

LifeCare® 5000
plum®
Concurrent Flow Infusion System
With DataPort™

List 2507-04

System
Operating
Manual

Abbott Laboratories
North Chicago, IL 60064
USA

430-03680-C01 (Rev. 7/98)

VERSION
1.6
SERIES



To Purchase, Visit Avobus.com or call 1-800-674-3655

CHANGE HISTORY

Part Number	Description of Change	Revised Pages
430-03680-001	Original issue	
430-03680-A01 (Rev.6/94)	Updated cover page	Cover
	Created Change History Page	i to vi
	Sec. 4: Deleted the color of the Flow Regulator	4-5 to 4-8
	Sec. 4: Deleted the color of the Flow Regulator	4-17, 4-18
	Sec. 6: Deleted the color of the Flow Regulator	6-1, 6-2
	Sec. 7: Deleted the color of the Flow Regulator	7-1 to 7-4
	Sec. 8: Updated Cleaning Solutions	8-1 to 8-4
	Sec. 9: Deleted the color of the Flow Regulator	9-1, 9-2
	Updated Back Cover	Back Cover
430-03680-B01 (Rev. 10/96)	Updated cover part number	Cover
	Updated Change History	i
	Updated copyright date	vi
	Updated syringe information	5-13
	Updated UL and CSA references; updated shipping address	Back Cover
430-03680-C01 (Rev. 7/98)	Updated Cover	Cover, Back
	Updated Change History	i
	Updated Table of Contents	iii, iv
	Updated List of Figures	v
	Updated Copyright Date	vi
	Inserted Instructions for Mode Configuration	Section 4 (all)

Note: Change page manuals assembled by Abbott laboratories include a change page identifier in the part number on the cover page, and at the bottom of each changed page. This change page manual is identified as 430-03680-C01.



To Purchase, Visit Avobus.com or call [1-800-674-3655](tel:1-800-674-3655)

This page intentionally left blank.

Contents

Section 1

INTRODUCTION	1-1
--------------------	-----

Section 2

PRINCIPLES OF OPERATION	2-1
-------------------------------	-----

Section 3

SYSTEM FEATURES	3-1
SYSTEM COMPONENTS	3-2

Section 4

CHECKOUT AND OPERATION	4-1
USER QUALIFICATION	4-1
MODE CONFIGURATION	4-1
INSTRUCTIONS	4-1
INSTRUMENT INSTALLATION PROCEDURE	4-3
UNPACKING	4-3
INSPECTION	4-3
OPERATIONAL TEST	4-3
USING THE FLOW DETECTOR	4-5
FLOW DETECTOR CONNECTED	4-5
NO FLOW DETECTOR CONNECTED	4-6
FLOW DETECTOR CONNECTED WHILE PUMPING	4-6
FLOW DETECTOR DISCONNECTED WHILE PUMPING	4-6
USING THE DATAPORT	4-6
ATTACHING DATAPORT ACCESSORIES	4-6
INFUSER SETUP	4-6
PREPARING SET AND CONTAINER	4-7
PROGRAMMING	4-9
CHANGING THE FLUID CONTAINER	4-18
DISCONTINUING ELECTRONIC FLOW CONTROL OR FLUID ADMINISTRATION	4-19

Section 5

USER OPTIONS	5-1
USING CONCURRENT DELIVERY FEATURE	5-1
CONCURRENT FLOW GUIDELINES WHEN DELIVERING CRITICAL DRUGS	5-4
DELIVERY RATE	5-4
CRITICAL DRUGS	5-4
USE OF NURSE CALL BACK FEATURE	5-5
BACKPRIMING	5-5
MANUAL BACKPRIMING	5-6
AUTO BACKPRIMING	5-8
DELIVERY SECONDARY OVERFILL OPTION	5-8
TITRATING	5-9
TITRATING PRIMARY RATE	5-9
TITRATING SECONDARY RATE	5-10

TITRATING EITHER PRIMARY OR SECONDARY RATE IN CONCURRENT DELIVERY	5-10
MUTING THE TOUCHSWITCH TONE	5-10
CHANGING THE PRESSURE LIMIT	5-11
USING RETROGRADE PROCEDURES	5-12
USING SYRINGES, VIALS, OR OTHER CONTAINERS FOR SECONDARY ADMINISTRATION	5-13
 Section 6	
ALARMS AND TROUBLESHOOTING	6-1
REVIEWING PREVIOUS ALARMS	6-1
 Section 7	
OPERATIONAL PRECAUTIONS	7-1
 Section 8	
MODE CONFIGURATION, MAINTENANCE, AND CLEANING	8-1
MODE CONFIGURATION	8-1
MAINTENANCE	8-1
BATTERY MAINTENANCE	8-1
CLEANING	8-2
 Section 9	
ADMINISTRATION SETS AND ACCESSORIES	9-1
PLUMSETS®	9-1
SINGLE-CHANNEL SETS	9-1
DUAL-CHANNEL SETS	9-2
ACCESSORIES	9-4
 Section 10	
SPECIFICATIONS	10-1
 Section 11	
WARRANTY	11-1

Figures

Figure 3-1. Front View 3-2

Figure 3-2. Closeup of Touchswitches 3-2

Figure 3-3. Diagram of Cassette (Dual-Channel Cassette Shown) 3-3

Figure 3-4. Rear View 3-3

Figure 4-1. Dip Switch Cover 4-1

Figure 4-2. Dip Switch Settings for Each Delivery Mode. 4-2

Figure 4-3. Sensor Pin 4-1

Figure 4-4. Mode Identification Displays 4-4

Figure 4-5. Preparing the Set and Container 4-7

Figure 4-6. Priming the Cassette 4-8

Figure 4-7. Inserting the Cassette. 4-8

Figure 4-8. Programming for Primary Delivery 4-10

Figure 4-9. Programming for Single Dose Secondary Delivery 4-11

Figure 4-10. Programming for Multiple Dose Secondary Delivery. 4-12

Figure 4-11. Reviewing Settings 4-14

Figure 4-12. Changing Settings 4-16

Figure 4-13. Clearing Settings 4-17

Figure 4-14. Changing the Fluid Container 4-18

Figure 4-15. Discontinuing Electronic Flow Control and Setting Up Gravity Administration. 4-19

Figure 4-16. Discontinuing Fluid Administration 4-19

Figure 5-1. Programming for Concurrent Delivery 5-2

Figure 5-2. Manual Backpriming (Dual-Channel Cassettes Only) 5-6

Figure 5-3. Clearing Proximal Air-in-Line Alarm With Manual Backpriming
(Dual-Channel Cassettes Only). 5-7

Figure 5-4. Settings and Retaining Pressure Limits 5-12

Figure 5-5. Using Retrograde Procedure 5-12

Figure 5-6. Using Infuser With Secondary Line, Syringe, or Vial 5-14

Figure 6-1. Accessing the Alarm History 6-1

Figure 8-1. Cleaning the Mechanical Elements Behind Cassette Door 8-3

Tables

Table 1-1. LifeCare 5000 Plum Infusion Mode Configurations	1-1
Table 5-1. Delivery Rate Guidelines	5-4
Table 6-1. Alarm/Action Table.....	6-2
Table 8-1. Cleaning Solutions	8-2

©Copyright 1998

Abbott Laboratories

All Rights Reserved

This document and the subject matter disclosed herein are proprietary information. Abbott Laboratories retains all the exclusive rights of dissemination, reproduction, manufacture and sale. Any party using this document accepts it in confidence, and agrees not to duplicate it in whole or in part nor disclose it to others without the written consent of Abbott Laboratories.

Section 1

INTRODUCTION

The LifeCare 5000 Plum Infusion System With DataPort is a multiline, general purpose, volumetric infusion system designed to meet the need for hospital-wide device standardization. By means of internal switch-settings, a qualified bio-technician can configure the system to best suit the clinical needs and census changes of the hospital. The infuser can be configured as shown in *Table 1-1, LifeCare 5000 Plum Infusion Mode Configurations*.

Table 1-1. LifeCare 5000 Plum Infusion Mode Configurations						
	NON-CONCURRENT		CONCURRENT (Combined)		NUMBER OF SECONDARY DOSES	DOSE INTERVALS
	RATE	DOSE	RATE	DOSE		
MACRO	1-999 mL/hr	1-9999 mL	2-700 mL/hr	2-19998 mL	none	none
MACRO SECONDARY	1-999 mL/hr	1-9999 mL	2-700 mL/hr	2-19998 mL	1	none
MACRO MULTIDOSE	1-999 mL/hr	1-9999 mL	2-700 mL/hr	2-19998 mL	2-24	15 minutes to 24 hours
MICRO	0.1-99.9 mL/hr	0.1-999 mL	1.0-99.9 mL/hr	0.2-1998 mL	none	none
MICRO SECONDARY	0.1-99.9 mL/hr	0.1-999 mL	1.0-99.9 mL/hr	0.2-1998 mL	1	none
MICRO MULTIDOSE	0.1-99.9 mL/hr	0.1-999 mL	1.0-99.9 mL/hr	0.2-1998 mL	2-24	15 minutes to 24 hours
VARIABLE PRESSURE LIMIT SELECTION	User selectable from approximately 0.1 psig to 10.0 psig					

The LifeCare 5000 Plum Infusion System With DataPort is designed for accurate, non-pulsatile administration of single fluid regimens, dual-channel regimens, piggybacks, and multidose regimens over a wide range of delivery rates and fluid viscosities. It can administer a variety of medical fluids, from 5% Dextrose Injection, USP, to enteral feeding products and blood. Primary and secondary doses of compatible drugs can be delivered concurrently.

A broad line of specially designed LifeCare 5000 PlumSet® administration sets and accessories permits the convenient and cost-efficient administration of general IV fluids and electrolytes, potent drugs such as dopamine, heparin, oxytocin, nitroprusside,

chemotherapeutic agents, antibiotics, blood and blood fractions, hyperalimentation products, enteral products, and solutions for irrigation procedures.

The availability of administration sets with either single-channel or secondary dual-channel cassettes facilitates the use of a wide variety of standard IV piggybacks, fullfills, partfills (including ADD-Vantage[®]), and pre-filled or user-prepared syringes and vials.

The DataPort communications function allows continuous monitoring of LifeCare 5000 Plum Infusers With DataPort connected to a properly equipped host computer located at a nursing station or other remote locations.

Additionally, the use of special PlumSets with capped secondary ports can reduce risks of needle stick and facilitate "needleless" practice.

These features make the infuser a universal device, usable in virtually all areas of patient care, including:

- ICU/CCU
- Mobile Intensive Care
- OB/GYN
- Cardiac Cath Lab
- OR/Anesthesia
- Burn Unit
- General Floor
- Emergency
- Pediatrics
- Neonatology
- Post-Op/Recovery
- Oncology
- Enteral
- Home Care

The sophistication of the variable pressure feature permits the user to set a maximum occlusion pressure limit.

The LifeCare 5000 Plum Infusion System With DataPort has been designed to be a cost-effective, labor-saving tool for the healthcare professional. Its many features make it the infusion system of choice in virtually every clinical setting where the precise and dependable infusion of fluids is required.

Section 2

PRINCIPLES OF OPERATION

The LifeCare 5000 Plum Infusion System With DataPort is a positive displacement infusion system with four components:

1. **LifeCare 5000 Infuser**—an electromechanical infuser with an array of status and warning indicators.
2. **LifeCare 5000 PlumSet Administration Sets**—sterile, one-piece, disposable fluid administration sets with in-line, easy-to-prime, single-channel or dual-channel cassettes.
3. **LifeCare Flow Detector (optional)**—monitors the presence or absence of drops in the drip chamber of the primary line. If the fluid container is empty, the flow detector senses the absence of flow and triggers an audible alarm. The pump reverts to the KVO rate. When the flow detector is not used, a dose limit must be set.
4. **LifeCare 5000 DataPort**—enables a healthcare professional to monitor the infuser from a remote location. Using optional communications accessories (see *Accessories, Section 9*), one or several infusers can be linked to a properly equipped host computer.

The infuser drives the cassette at a precisely controlled stroke length and rate to provide accurate volumetric fluid delivery. Visual and audible alarms are activated by deviations from desired operation.

An internal microprocessor monitors and controls all hardware and circuitry. Whenever a cassette is locked into the operating position, the infuser goes through a brief self-test to verify the integrity of all internal systems and performs a pressure test of the cassette.

This page intentionally left blank.

Section 3

SYSTEM FEATURES

Special features of the LifeCare 5000 Plum Infusion System With DataPort include:

- Precise volumetric accuracy
- Microprocessor control
- Touchswitch operation, with full user prompting
- Flow detector for detection of empty container (optional)
- DataPort
- Continuous secondary
- Nurse Call Back
- Micro and Macro Mode configurations
- Selectable single-channel/dual-channel delivery
- User-selectable concurrent delivery
- Simple operation
- Wide choice of administration sets
- "Deliver Secondary Overfill" option
- Manual and automatic backpriming
- Titration
- User-selectable occlusion pressure limit
- Continuous pressure monitoring and readout
- Self-prompting Liquid Crystal Display (LCD)
- Light-Emitting Diode numerals (LEDs)
- Operating symbols
- Dose end/KVO
- Self-contained battery
- Air-trap cassette
- Safety and warning features, including:
 - Automatic self-test
 - Malfunction detector
 - Proximal air-in-line sensor
 - Distal air-in-line sensor
 - Proximal and distal occlusion sensor
 - Cassette pressure test
 - "No free flow" system design

SYSTEM COMPONENTS

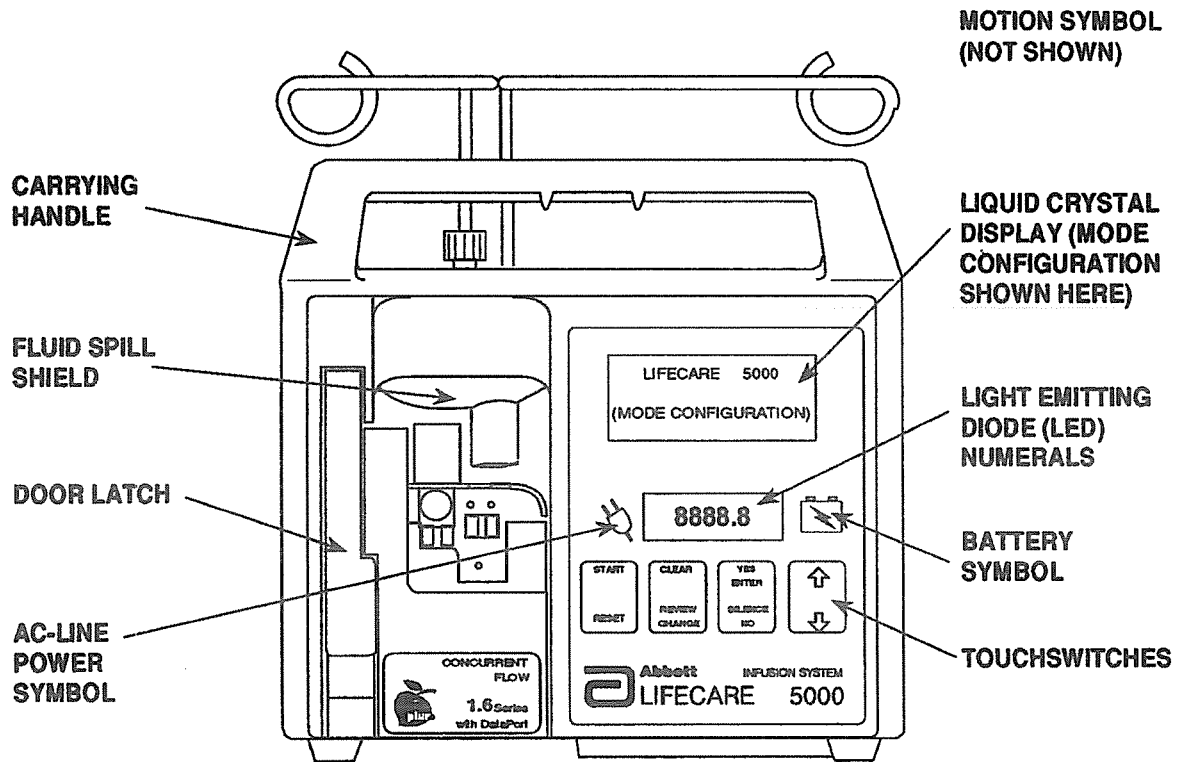

Figure 3-1. Front View

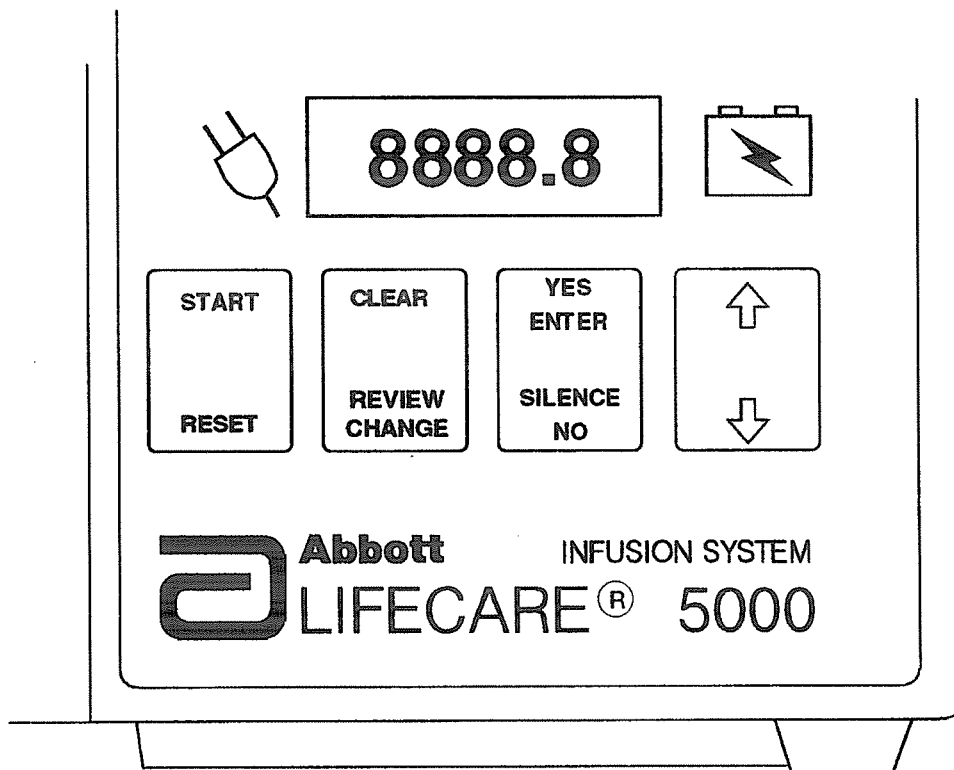

Figure 3-2. Closeup of Touchswitches

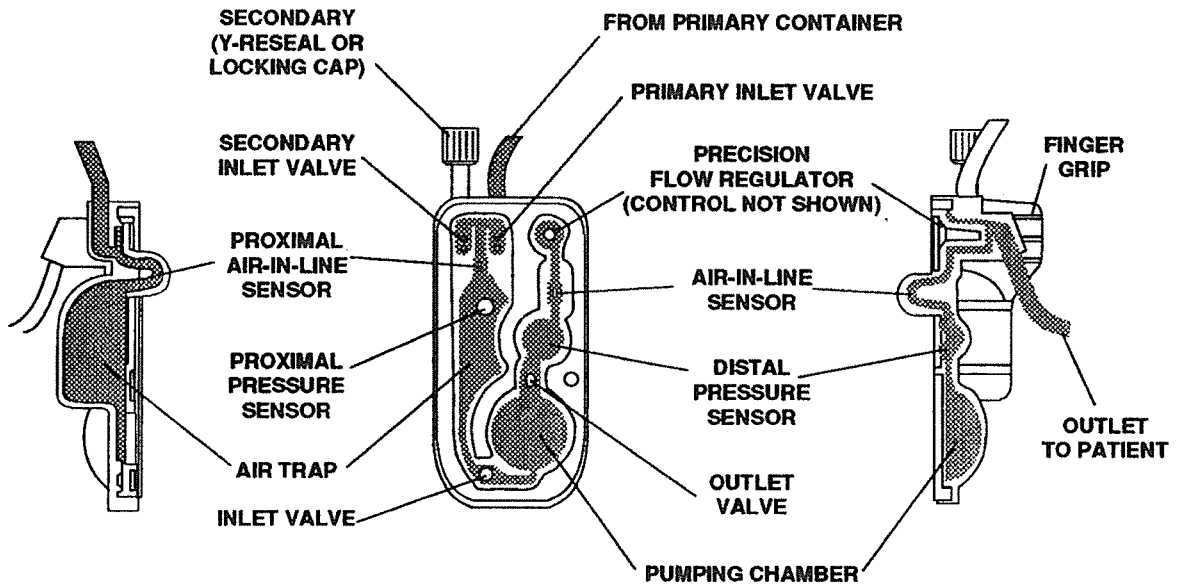

Figure 3-3. Diagram of Cassette (Dual-Channel Cassette Shown)

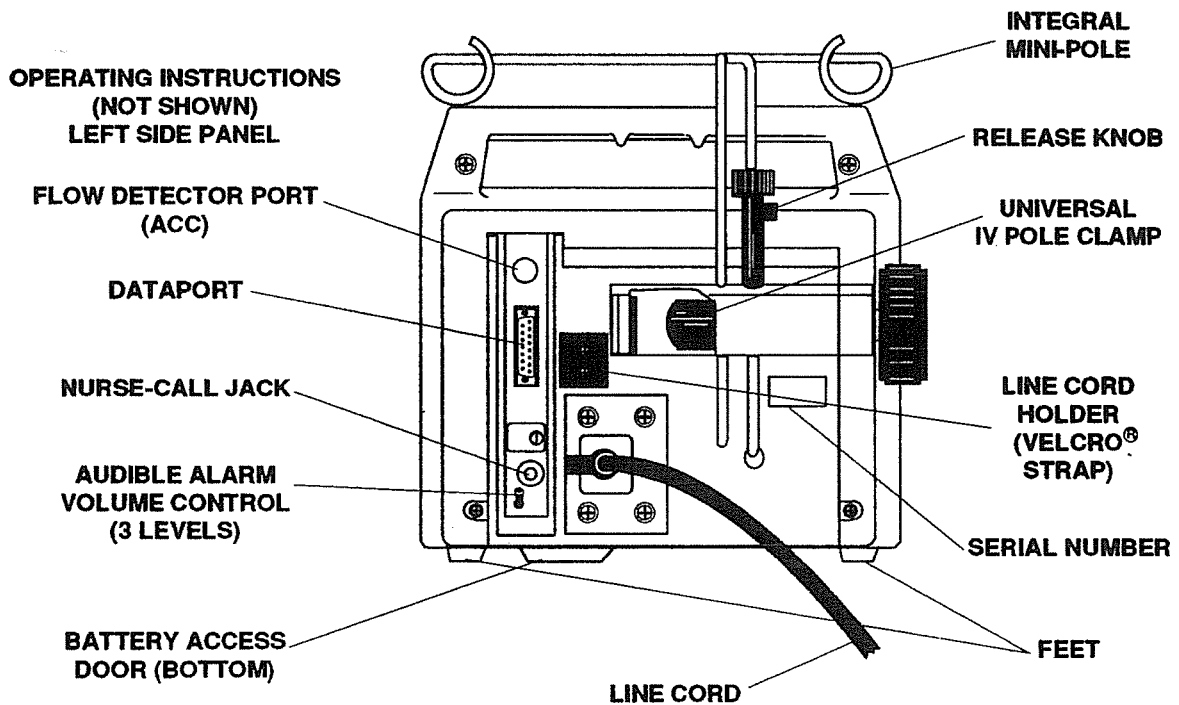

Figure 3-4. Rear View



To Purchase, Visit Avobus.com or call [1-800-674-3655](tel:1-800-674-3655)

This page intentionally left blank.

Section 4

CHECKOUT AND OPERATION

USER QUALIFICATION

The LifeCare 5000 Plum Infusion System With DataPort is for use at the direction or under the supervision of licensed physicians, or by licensed or certified healthcare professionals who are trained in the use of the infuser and the administration of parenteral or enteral fluids and drugs.

MODE CONFIGURATION

The infuser is internally configurable for a range of operating modes. When shipped, the infuser is configured for Macro Mode, Dual-Channel Delivery. All other configurations must be enabled by a qualified hospital technician.

INSTRUCTIONS

1. Remove dip switch cover (see Figure 4-1).
2. Determine configuration required for device.
3. Using a small screwdriver, (approximately 1/16 inch or equivalent), move the dip switches to the desired position. Figure 4-2 (next page) details dip switch settings for each delivery mode.
4. Confirm setup by pressing cassette sensor pin (see Figure 4-3). The LCD display panel will be activated and indicate selected configuration.
5. Reattach dip switch cover.

Figure 4-1. Dip Switch Cover

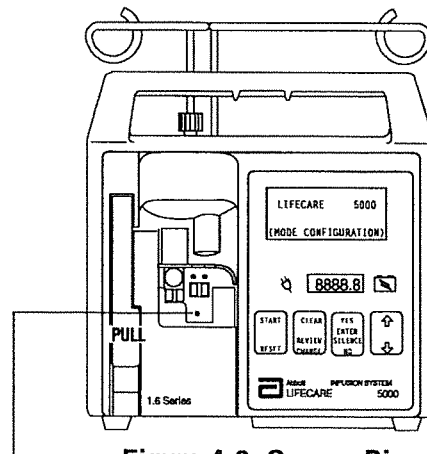
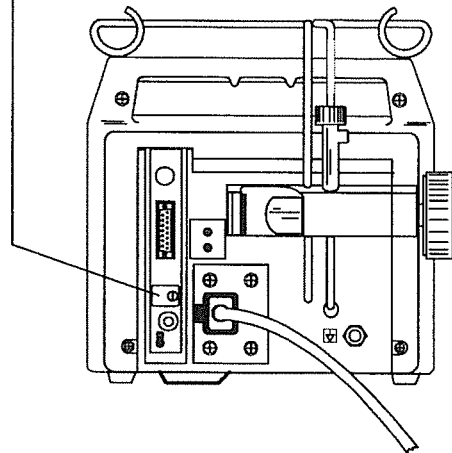

Figure 4-3. Sensor Pin





DELIVERY MODE	DIP SWITCH SETTING	DISPLAY LEGEND CONFIRMATION
MACRO (Single Channel)		LIFECARE 5000
MACRO SECONDARY (Dual Channel, Single Dose)		LIFECARE 5000 DUAL CHANNEL
MACRO MULTIDOSE (Dual Channel, Multidose)		LIFECARE 5000 MULTIDOSE
MICRO (Single Channel)		LIFECARE 5000 MICRO MODE
MICRO SECONDARY (Dual Channel, Single Dose)		LIFECARE 5000 MICRO MODE DUAL CHANNEL
MACRO MULTIDOSE (Dual Channel, Multidose)		LIFECARE 5000 MICRO MODE MULTIDOSE

Figure 4-2. Dip Switch Settings for Each Delivery Mode

INSTRUMENT INSTALLATION PROCEDURE

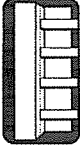
WARNING

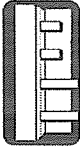
PRODUCT DAMAGE MAY OCCUR UNLESS PROPER CARE IS EXERCISED DURING THE UNPACKING AND INSTALLATION PROCESS. THE BATTERY MAY NOT BE FULLY CHARGED UPON RECEIPT. DO NOT PLACE UNIT IN SERVICE IF IT FAILS THE OPERATIONAL TEST OR SELF-TEST.

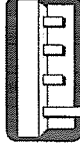
Note: Instrument installation should be performed by qualified personnel only.

UNPACKING

Use care when unpacking the infuser. Retain the packing slip and save all packing material in case the device is damaged or fails the infuser Self-Test and has to be returned to the factory.

INSPECTION

Inspect the packing container for possible shipping damage to infuser. Should any damage be found, contact the delivering carrier immediately. Freight claims or insurance claims must be filed by the receiving party with the carrier within seven days. Recourse to the carrier is lost if claim is not timely.

Next, inspect infuser thoroughly for damage. Do not use infuser if it appears to be damaged.

OPERATIONAL TEST

Note: Do not place infuser in service until the Operational Test has been conducted. The procedure provided below should be performed by qualified personnel only.

To perform the Operational Test, proceed as follows:

1. Plug the AC line cord into a grounded, hospital-grade, 100-130 VAC, 50-60 Hz receptacle and observe a lighted AC power symbol (plug) on the front panel.
2. Lift the doorlatch that operates the cassette receptacle and, holding a primed cassette on a PlumSet administration set by its finger grip, insert it into the door guides. Do not force the cassette. It should slide into the guides easily.
3. Push the doorlatch down to close and lock the cassette in place.
4. If used, confirm that the flow detector is securely connected to the receptacle at the rear of the pump.

Note: If the flow detector is not connected properly and a dose limit is not set, the infuser will not start delivery.

At this point, the infuser will automatically initiate a self-test sequence to check its internal systems. When complete, the display panel will read:

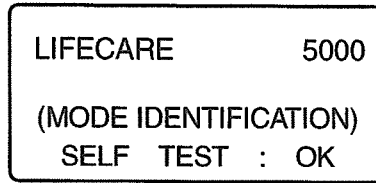

1-15-001

Note: Valve test will complete approximately 30 seconds after SELF TEST OK is displayed.

Mode identification displays for the various mode configurations are shown in *Figure 4-4, Mode Identification Display*.

MODE	MODE IDENTIFICATION DISPLAY
MACRO	
MICRO	
MACRO SECONDARY	
MICRO SECONDARY	
MACRO MULTIDOSE	
MICRO MULTIDOSE	
	* MODE AS SHIPPED

1-15-002

Figure 4-4. Mode Identification Displays

The Mode identification display indicates that the infuser is ready for use. The display will change after a few seconds to read:

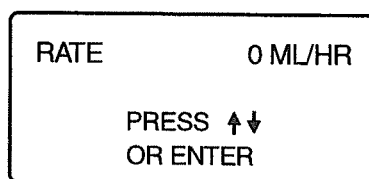

1-15-003

Alternately, if any settings remain in memory from previous use, the display will read:

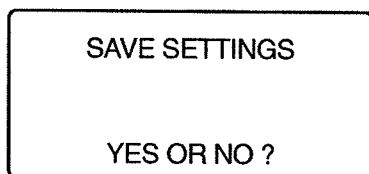

1-15-004

5. When the self-test is completed, unplug the infuser from the AC circuit. A backlighted, red battery symbol will appear, indicating that the infuser has switched to battery power. To ensure the battery is charged, plug the unit back in and leave it on the AC circuit for a minimum of 16 hours.
6. Open the doorlatch, remove the cassette from its receptacle, and close the latch again.

Note: If any malfunction is detected by the self-test, an audible alarm will sound and the display will show a malfunction code number. Should this occur, refer to Alarms and Troubleshooting, Section 6.

USING THE FLOW DETECTOR

The LifeCare 5000 Infuser (1.6 Series) works with the LifeCare Flow Detector. The flow detector is an optional feature to be used only on the primary line for detecting an empty container. Using the flow detector will reduce the chance of air entering the cassette air trap.

Note: A 0 mL dose limit can be entered only if the flow detector is attached.

The flow detector works with the infuser in the following manner:

FLOW DETECTOR CONNECTED

If the flow detector is plugged in during setup, a dose limit is not required. If no dose limit is set, the infuser runs until the primary container empties. The flow detector senses the absence of flow and an EMPTY CONTAINER PRIMARY alarm is triggered. During an EMPTY CONTAINER PRIMARY alarm, the infuser automatically switches to the KVO rate.

NO FLOW DETECTOR CONNECTED

If flow detector is not connected during setup, a dose limit must be set for primary delivery. The pump will not leave the setup mode unless a dose limit is set.

FLOW DETECTOR CONNECTED WHILE PUMPING

If the flow detector is connected while the infuser is pumping, a FLOW DETECTOR CONNECTED alarm is generated and the pump stops delivery. Press [RESET] touchswitch to both silence the alarm and to put the pump into the Reset mode. Press [START] touchswitch to continue delivery. If a limit has been set, the infuser will continue pumping until the empty container is detected or the dose limit is reached, whichever comes first.

FLOW DETECTOR DISCONNECTED WHILE PUMPING

If the flow detector is disconnected while pumping, a CONNECT FLOW DETECTOR message is generated and the pump stops delivery.

To continue delivery without reconnecting the flow detector, press [RESET] touchswitch and follow the user prompts to set a dose limit for primary delivery.

USING THE DATAPORT

The LifeCare 5000 Infuser With DataPort can utilize optional communications accessories to establish a link between one or several infusers and a host computer (see Accessories, Section 9). When the infuser is linked to a properly equipped host computer, infuser status can be monitored from a remote location.

Note: The communications link between the infuser and the host PC is monitor only. The infuser cannot be controlled from a remote location.

ATTACHING DATAPORT ACCESSORIES

Note: See accompanying documentation packaged with LifeCare 5000 DataPort accessories for installation procedures.

Note: Attaching or removing accessories from the DataPort while the device is pumping will not affect infuser operation.

INFUSER SETUP

To set up the infuser, proceed as follows:

1. Plug the AC cord into a hospital-grade AC receptacle, unless battery operation is desired.

Note: Use AC power whenever possible. Store infuser plugged-in to ensure a fully charged battery for emergencies.

Note: If quality of earth grounding source is in doubt, use battery power.

2. Set the audible alarm switch on the rear of the infuser to the desired volume level: low, medium, or high.

PREPARING SET AND CONTAINER

WARNING

ARRANGE TUBING, CORDS, AND CABLES TO MINIMIZE THE RISK OF PATIENT STRANGULATION OR ENTANGLEMENT.

Figures 4-5 and 4-6 illustrate the preparation of the PlumSet and container. Figure 4-7, *Inserting the Cassette*, shows proper loading of the cassette into the infuser.

Note: This procedure is only for the basic dual-channel PlumSets, List Numbers 6426-02 and 6432-02. See individual set instructions for use of other PlumSet administration sets.

Note: Using aseptic technique, remove protective coverings as assembly progresses.

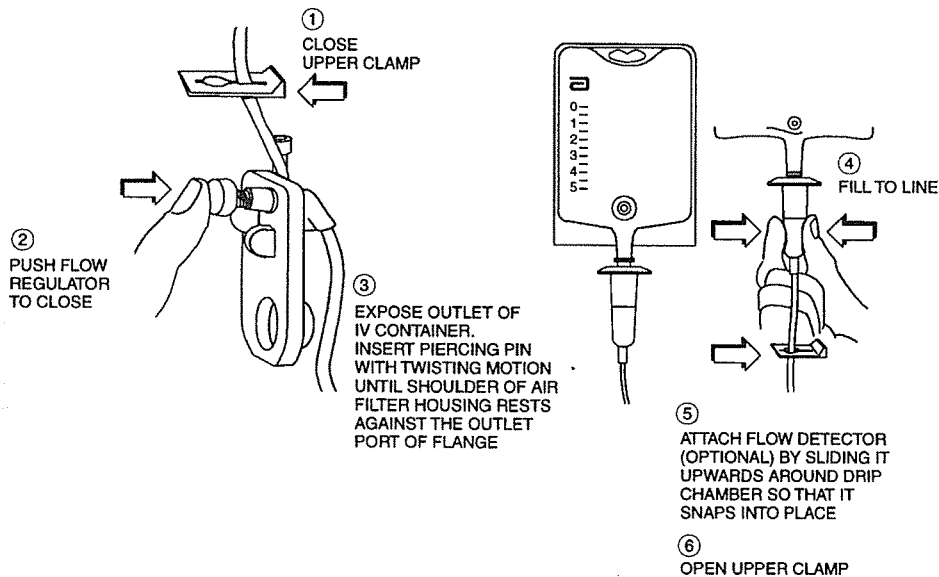

Figure 4-5. Preparing the Set and Container

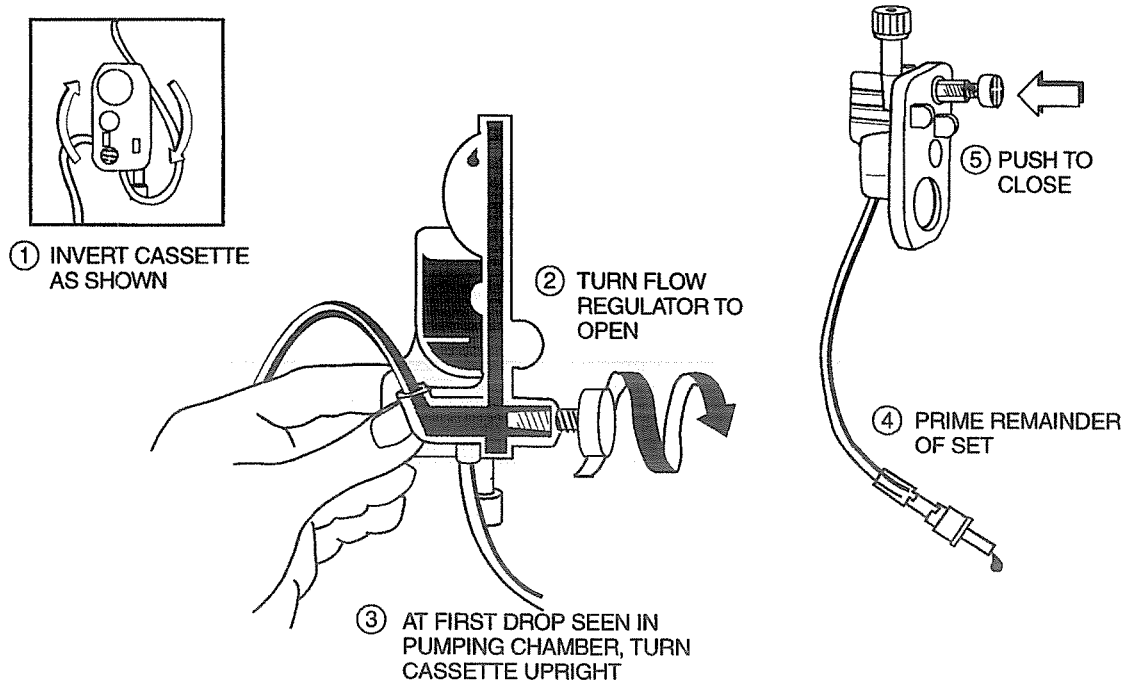

Figure 4-6. Priming the Cassette

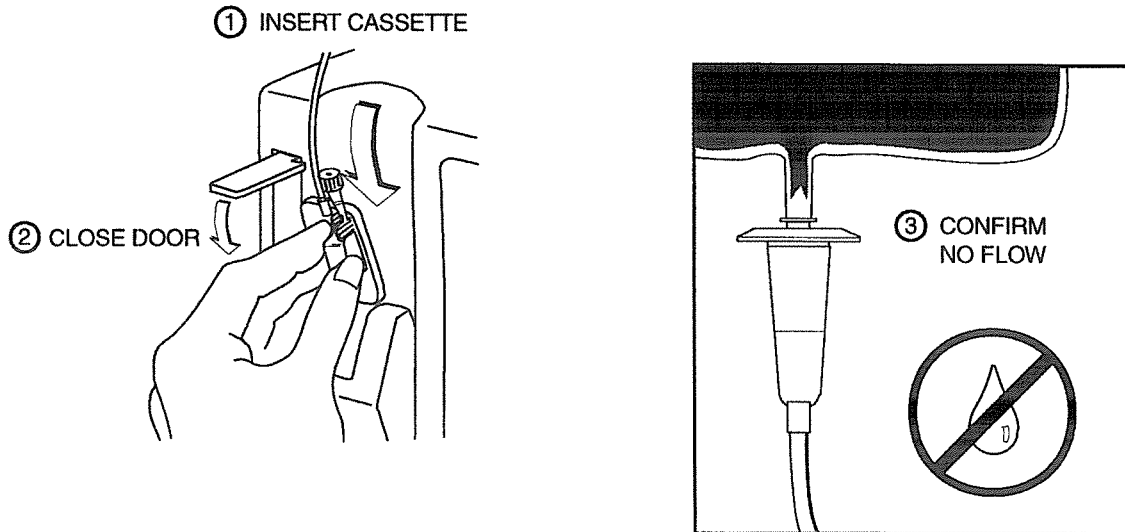

Figure 4-7. Inserting the Cassette

PROGRAMMING

The LifeCare 5000 Plum Infuser With DataPort has the ability to perform several modes of fluid administration as listed below:

- Primary only
- Secondary delivery (Dual-Channel)
 - single dose
 - multiple dose

which may be run in either intermittent or continuous concurrent modes.

In order to configure the device for desired fluid administration, please refer to the LifeCare 5000 Technical Service Manual. The LifeCare 5000 Infuser should only be configured by qualified technical personnel.

Note: When delivering in Multiple Dose Secondary (Dual-Channel) Mode, the total volume in the multidose secondary container must at least equal the cumulative total required volume as determined by volume per dose times the number of programmed doses.

See *Figures 4-8 through 4-13* for programming, reviewing, and clearing procedures.

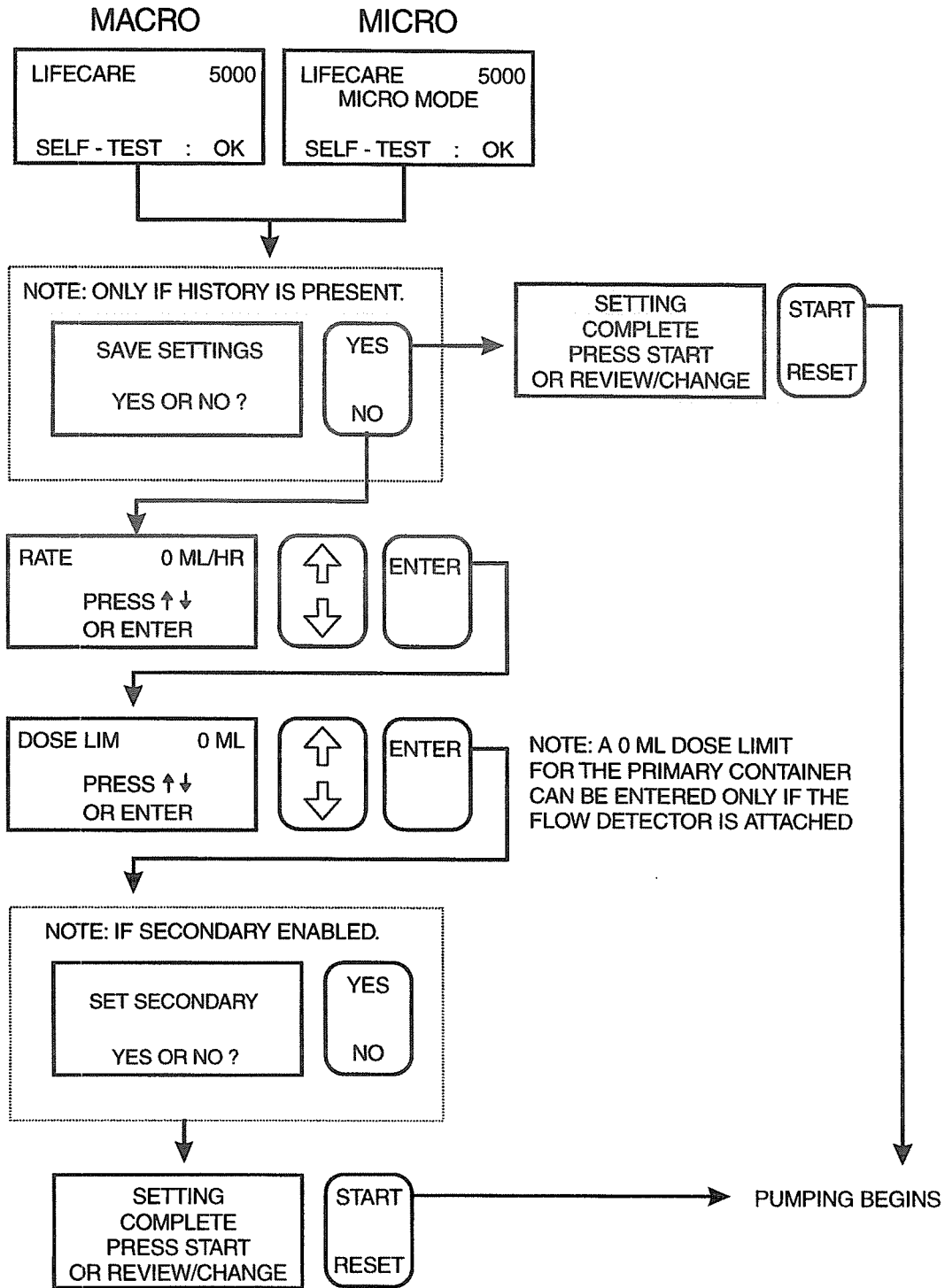

1-15-005

Figure 4-8. Programming for Primary Delivery

NOTE: PRIMARY DELIVERY MUST FIRST BE ESTABLISHED, AS SHOWN ON FIGURE 4-8, PROGRAMMING FOR PRIMARY DELIVERY

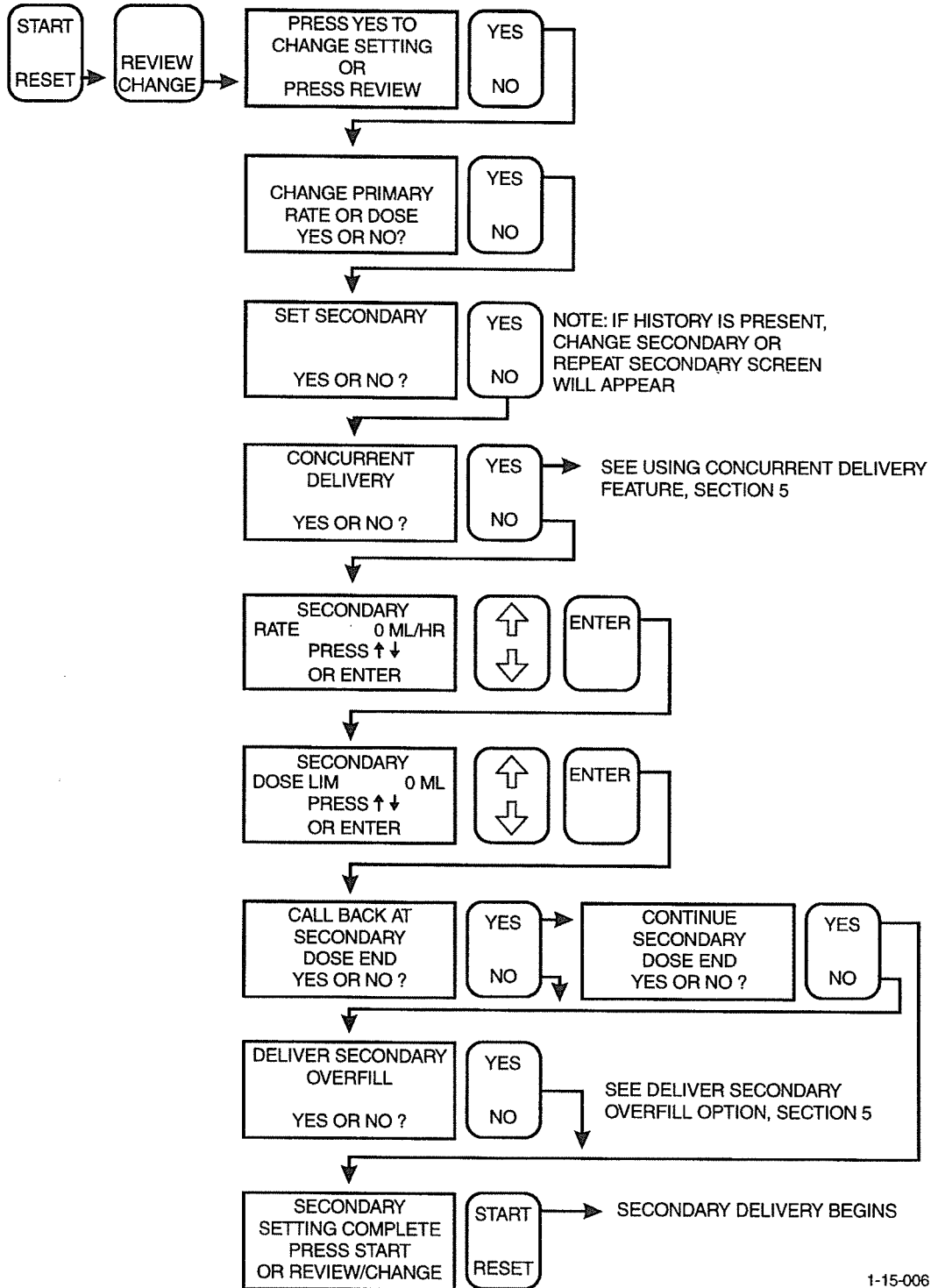

1-15-006

Figure 4-9. Programming for Single Dose Secondary Delivery



Section 4 CHECKOUT AND OPERATION

NOTE: THE INFUSER MUST BE CONFIGURED FOR MULTIPLE DOSE SECONDARY DELIVERY BY QUALIFIED TECHNICAL PERSONNEL. THE FOLLOWING INSTRUCTIONS ASSUME FAMILIARITY WITH THE SETUP AND OPERATION OF THE INFUSER IN BOTH PRIMARY AND SINGLE DOSE SECONDARY MODES.

NOTE: PRIMARY DELIVERY MUST FIRST BE ESTABLISHED, AS SHOWN ON FIGURE 4-8, PROGRAMMING FOR PRIMARY DELIVERY

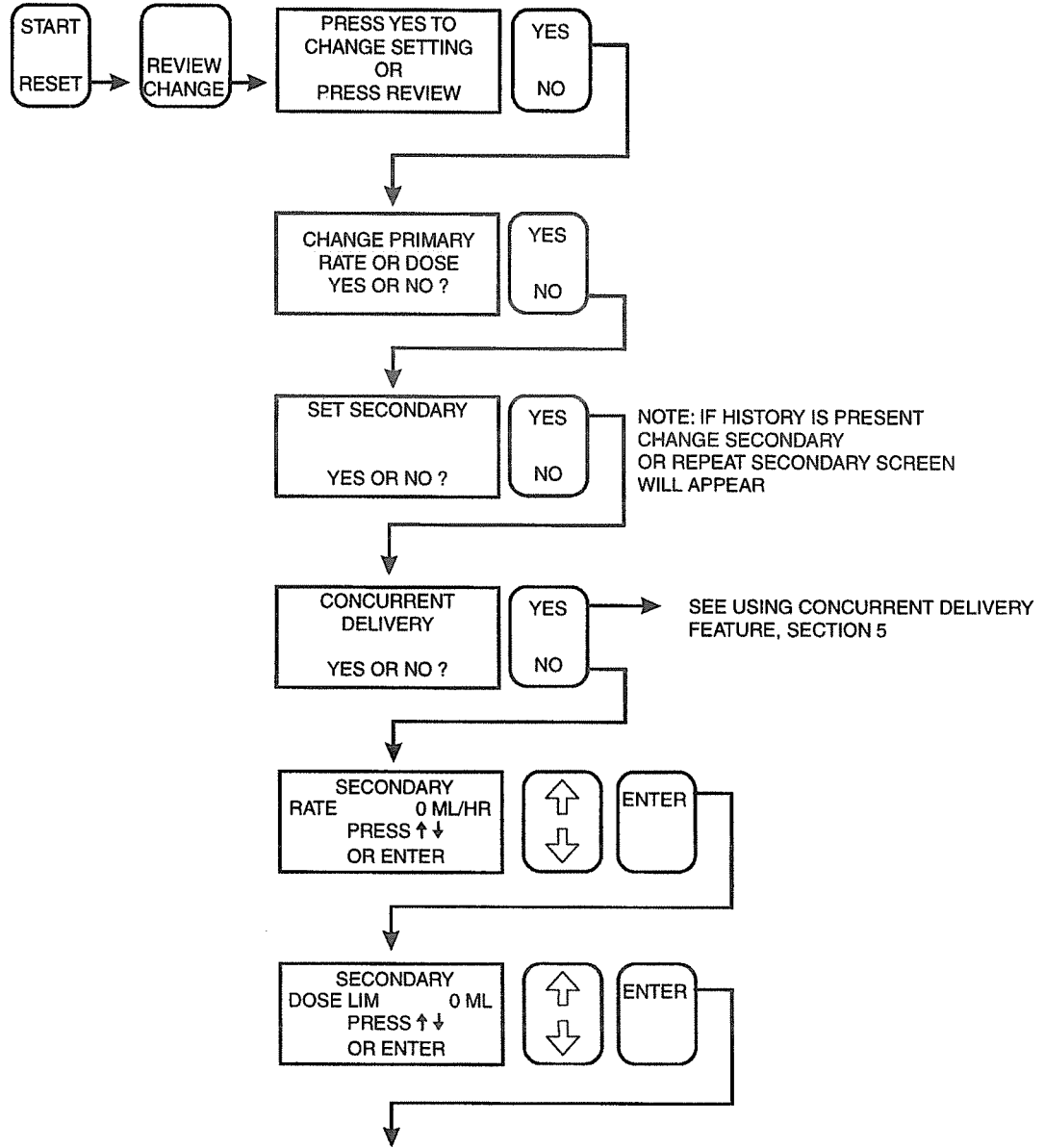

GO TO FIGURE 4-10, PROGRAMMING FOR MULTIPLE DOSE SECONDARY DELIVERY (2 OF 2)

1-91-007

Figure 4-10. Programming for Multiple Dose Secondary Delivery (1 of 2)

CONTINUED FROM FIGURE 4-10, PROGRAMMING FOR MULTIPLE DOSE SECONDARY DELIVERY (1 OF 2)

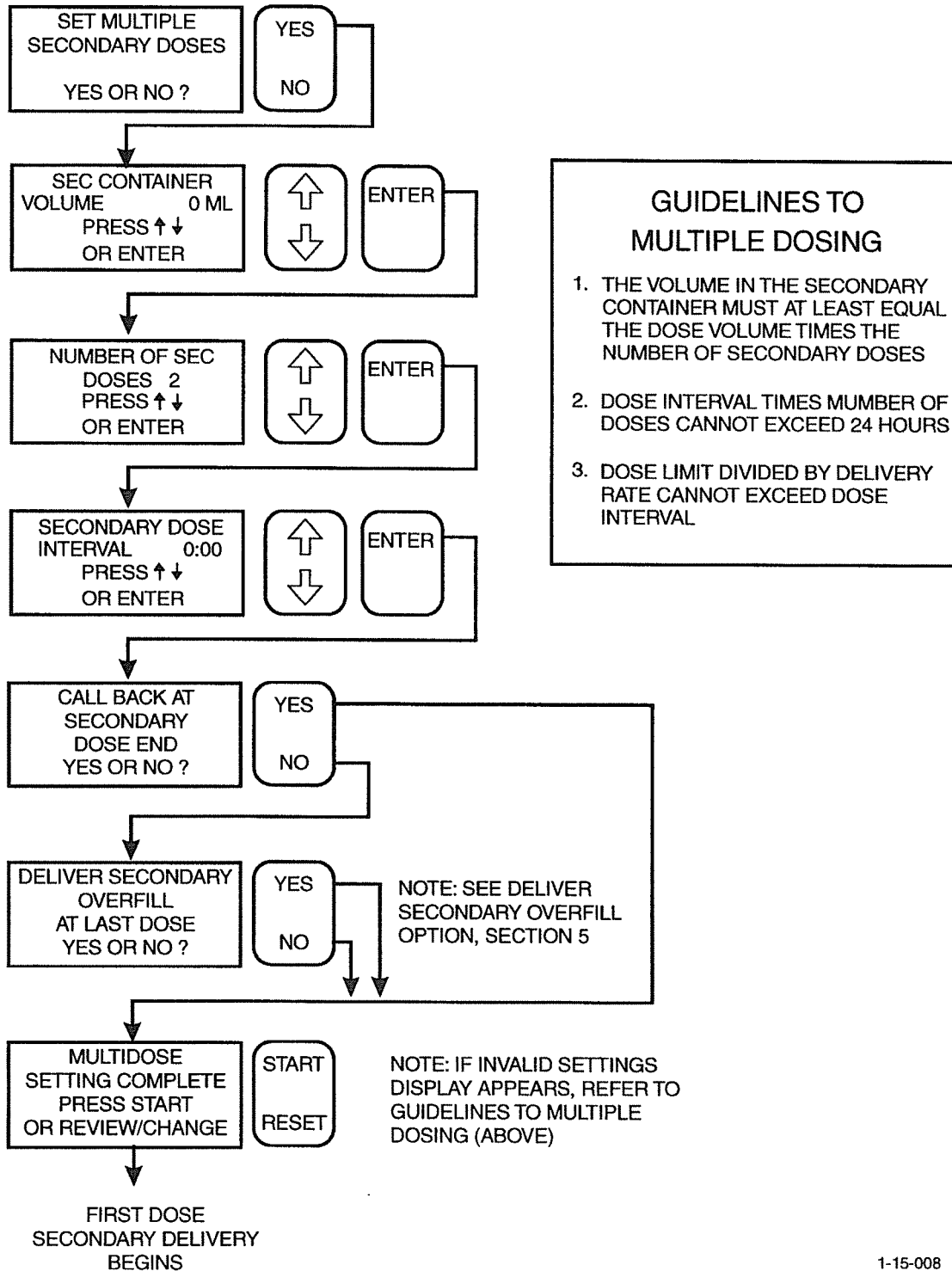
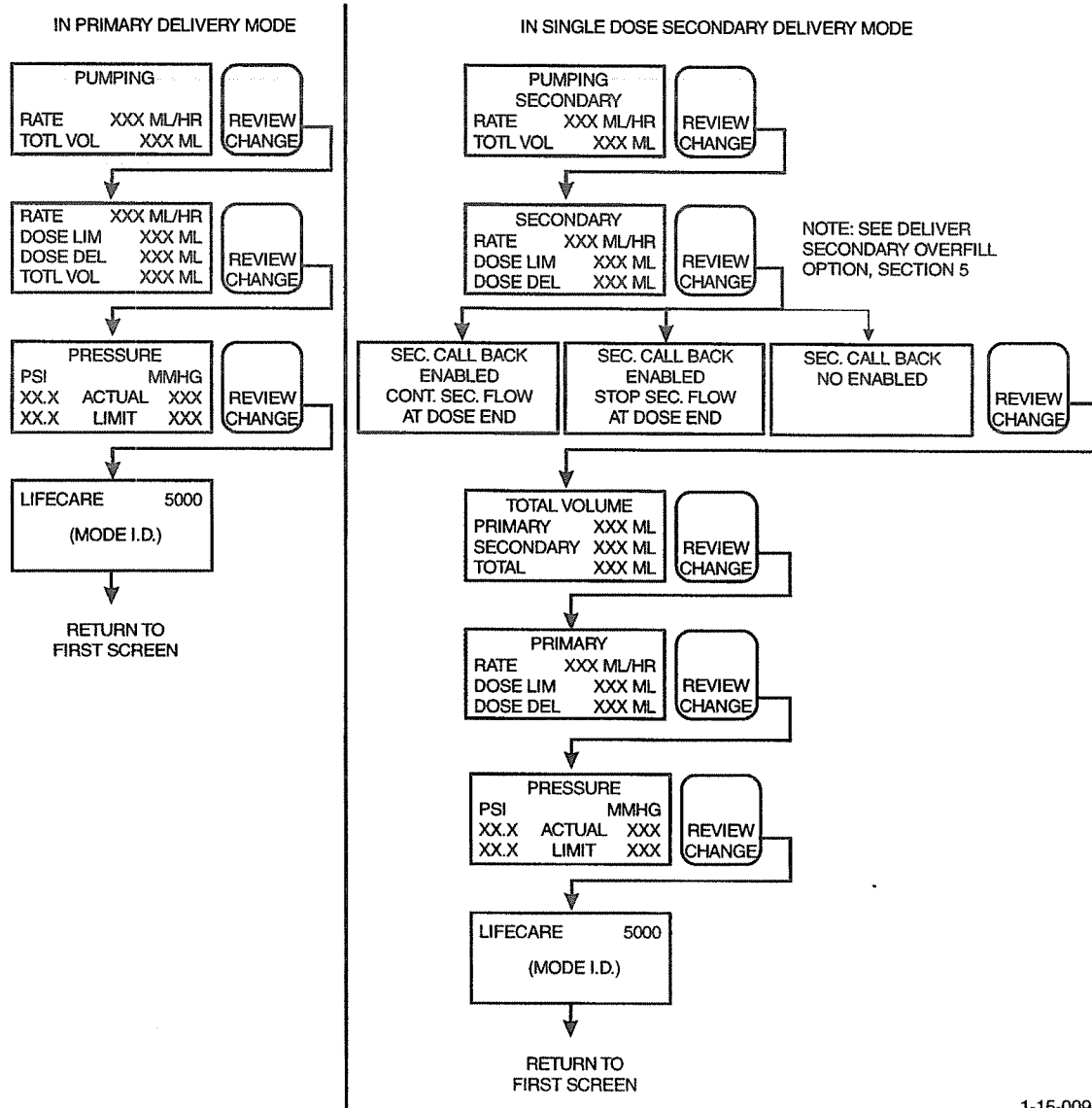

Figure 4-10. Programming for Multiple Dose secondary Delivery (2 of 2)



1-15-009

Figure 4-11. Reviewing Settings (1 of 2)

IN MULTIPLE DOSE SECONDARY DELIVERY MODE

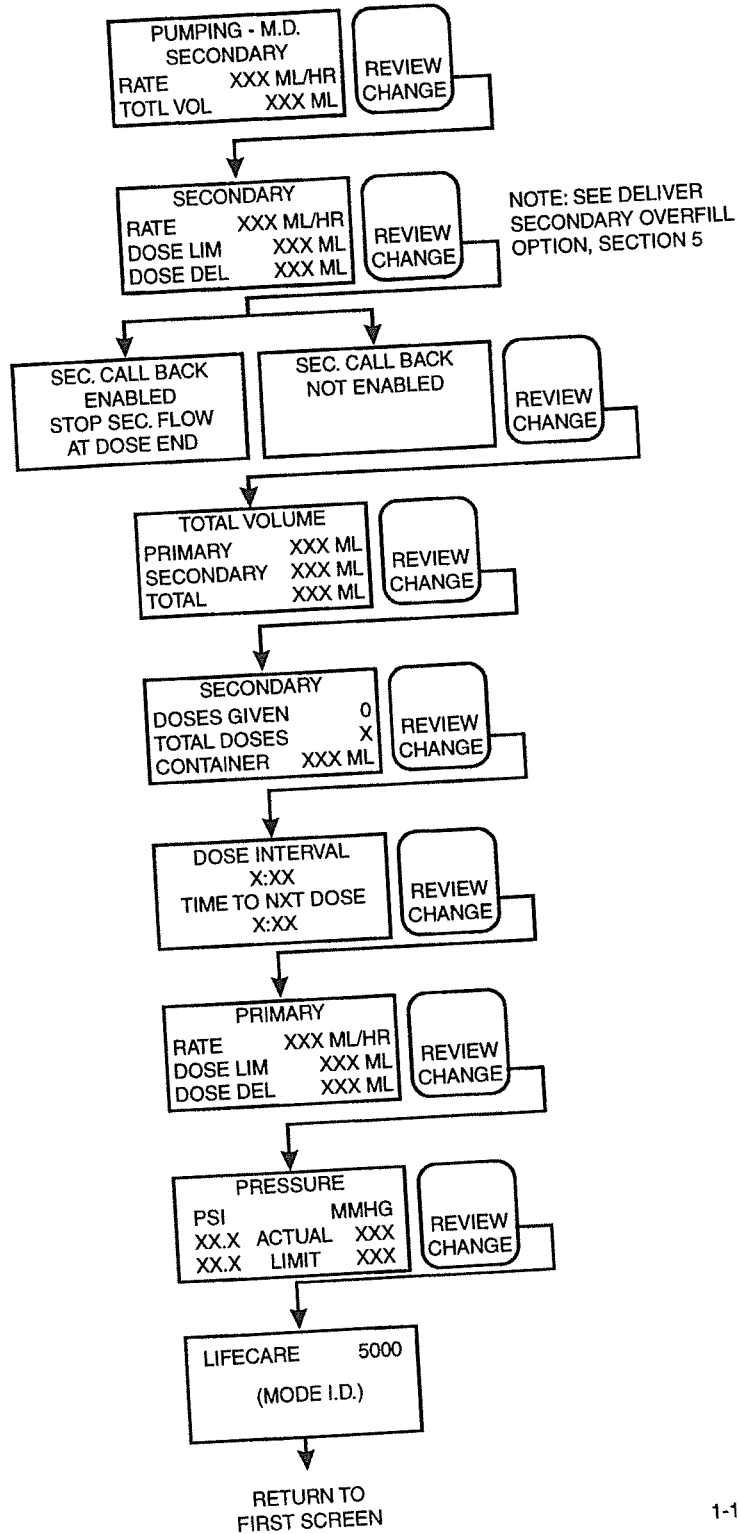
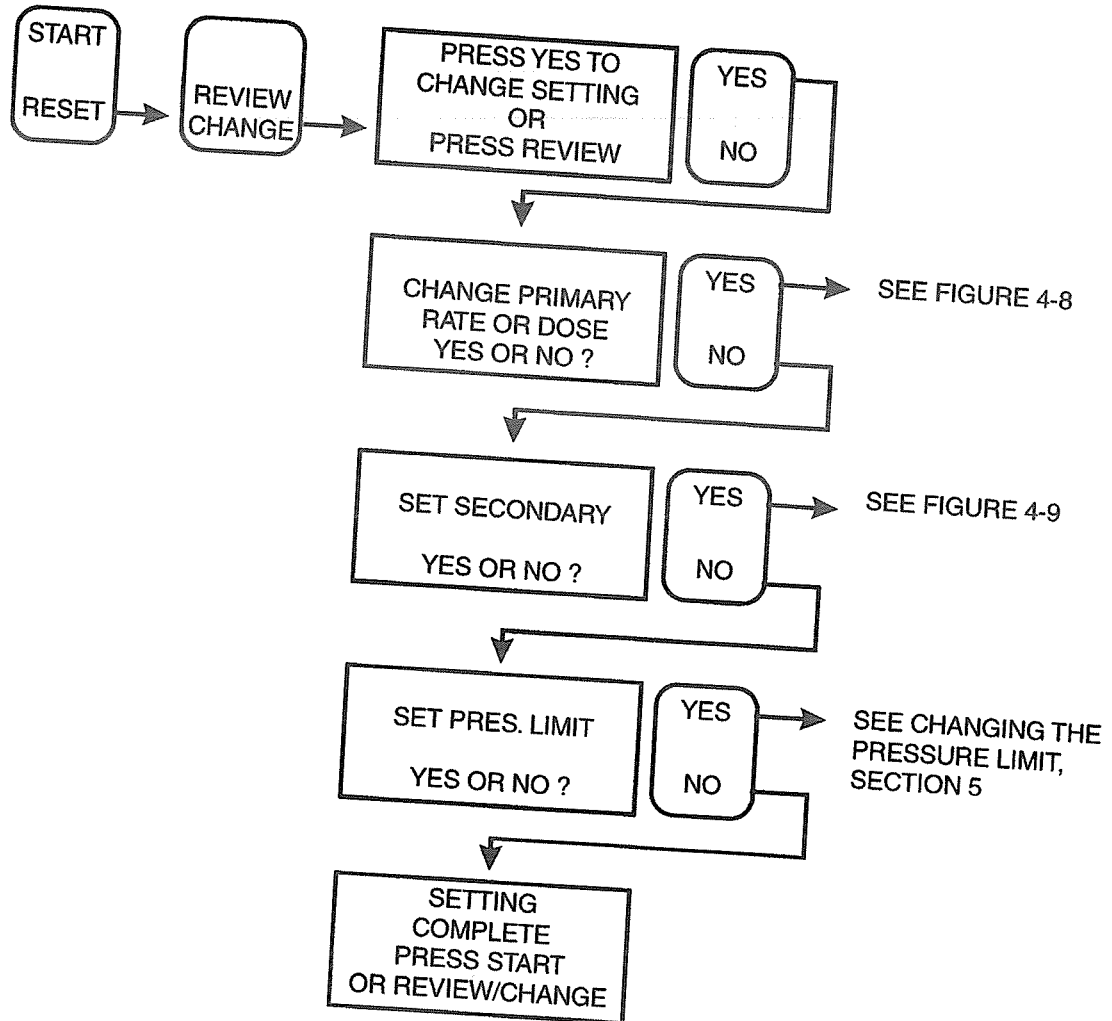

Figure 4-11. Reviewing Settings (2 of 2)

1-15-010



1-91-011

Figure 4-12. Changing Settings

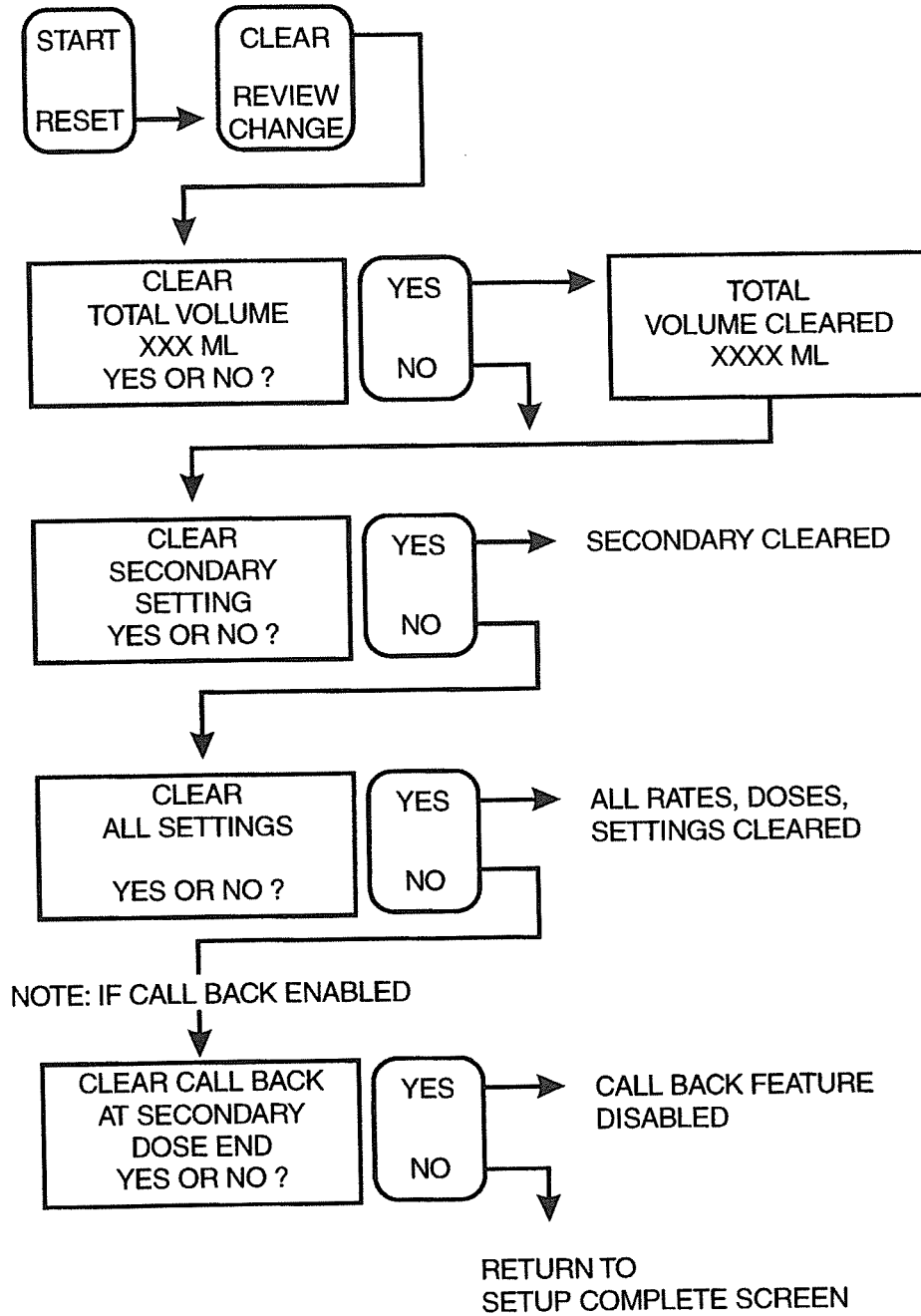

1-91-012

Figure 4-13. Clearing settings

CHANGING THE FLUID CONTAINER

CAUTION: Before opening door, close clamp on primary or secondary set or remove secondary container from secondary port to prevent mixing of primary and secondary fluids.

See *Figure 4-14, Changing the Fluid Container* for instructions on changing a primary or secondary fluid administration container.

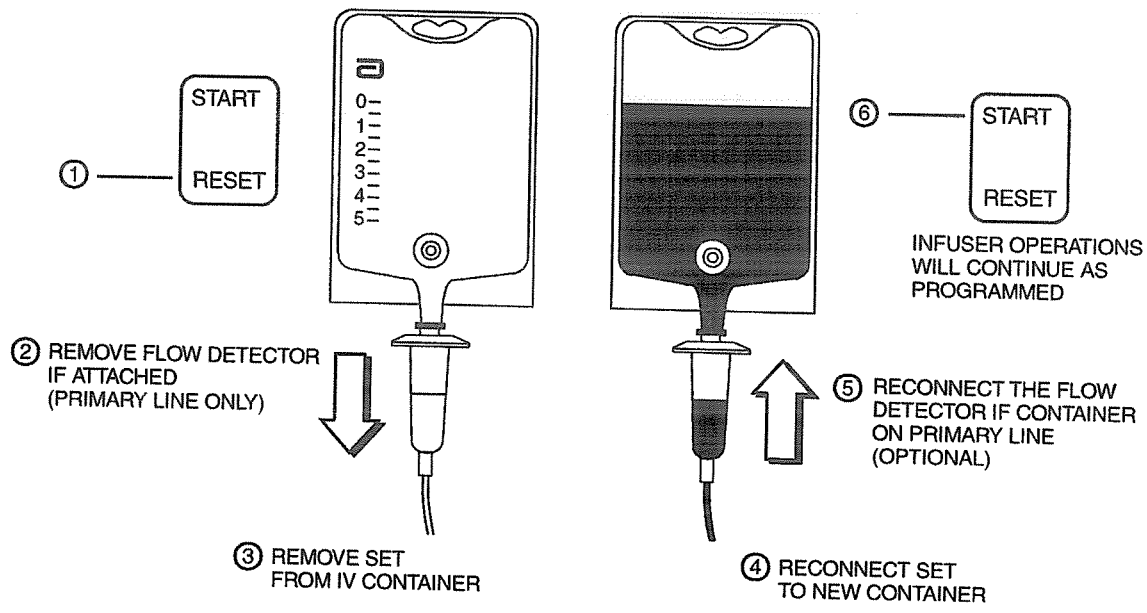
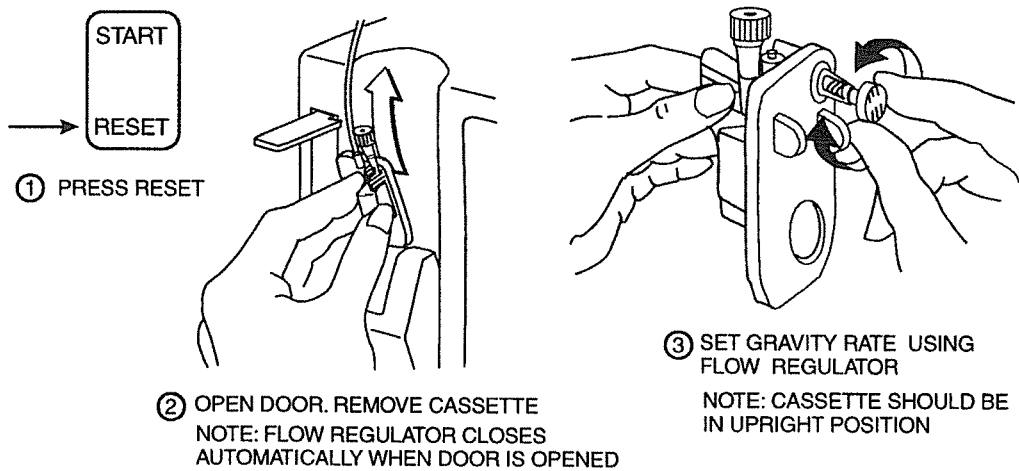

Figure 4-14. Changing the Fluid Container

DISCONTINUING ELECTRONIC FLOW CONTROL OR FLUID ADMINISTRATION

CAUTION: Before opening door, close clamp on primary or secondary set or remove secondary container from secondary port to prevent mixing of primary and secondary fluids.

If electronic flow control needs to be stopped, the precision flow regulator on the cassette can be used to manually set and maintain fluid flow in a gravity mode (see Figure 4-15, *Discontinuing Electronic Flow Control and Setting Up Gravity Administration*). Figure 4-16, *Discontinuing Fluid Administration*, illustrates how to properly remove an administration set from the infuser.



NOTE: IF DOOR OPEN ALARM OCCURS, PRESS RESET

Figure 4-15. Discontinuing Electronic Flow Control and setting Up Gravity Administration

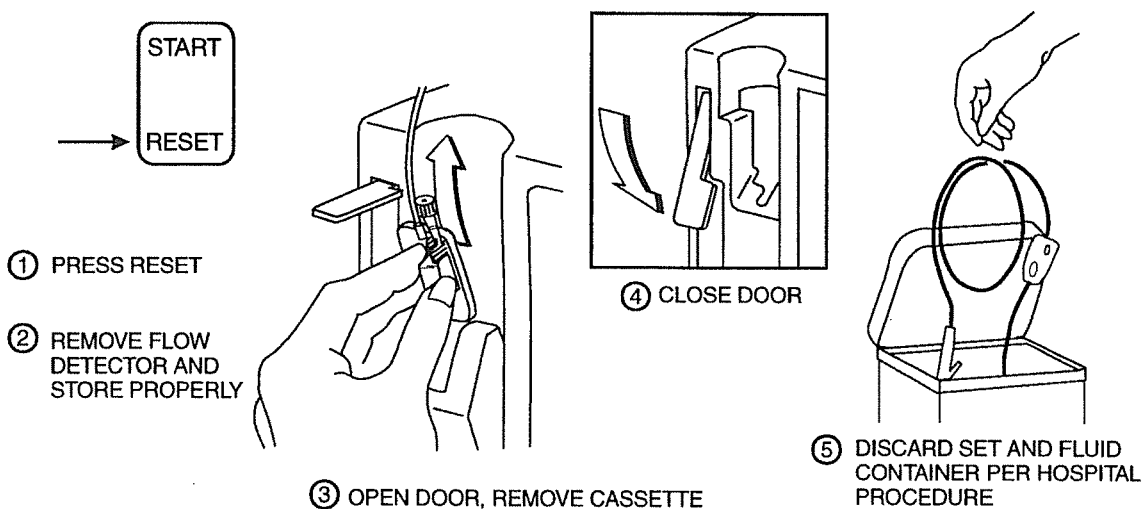

Figure 4-16. Discontinuing Fluid Administration

This page intentionally left blank.

Section 5

USER OPTIONS

USING CONCURRENT DELIVERY FEATURE

The LifeCare 5000 Plum Infuser With DataPort has the ability to deliver primary and secondary fluids concurrently at different rates (*see Figure 5-1, Programming for Concurrent Delivery*). Limitations are as follows:

- ❑ Neither the primary rate nor the secondary rate can be less than 1 mL/hr (0.5 mL/hr in Micro Mode).
- ❑ The total of the primary rate plus the secondary rate cannot exceed 700 mL/hr in Macro Mode or 99.9 mL/hr in Micro Mode.
- ❑ The selected doses of primary and secondary fluids will be delivered to the patient at the total programmed rate (primary plus secondary rate) per hour as prescribed. However, the final concentration delivered may vary over time and depends on the ratio of the two delivery rates.

Note: Variation in patient response may occur with certain drugs with short half-life. Variations can be avoided by either maintaining a flow rate of greater than 5 mL/hr for the short half-life drug or by ensuring that the rates of the concurrent infusions conform to the concurrent flow guidelines (*see Concurrent Flow Guidelines When Delivering Critical Drugs, this section*).

Note: When using the LifeCare 5000 Plum Infuser With DataPort for concurrent delivery of primary and secondary fluids, confirm that the drugs/fluids being administered are chemically and physically compatible.

NOTE: PRIMARY DELIVERY MUST FIRST BE ESTABLISHED, AS SHOWN ON FIGURE 4-5, PROGRAMMING FOR PRIMARY DELIVERY

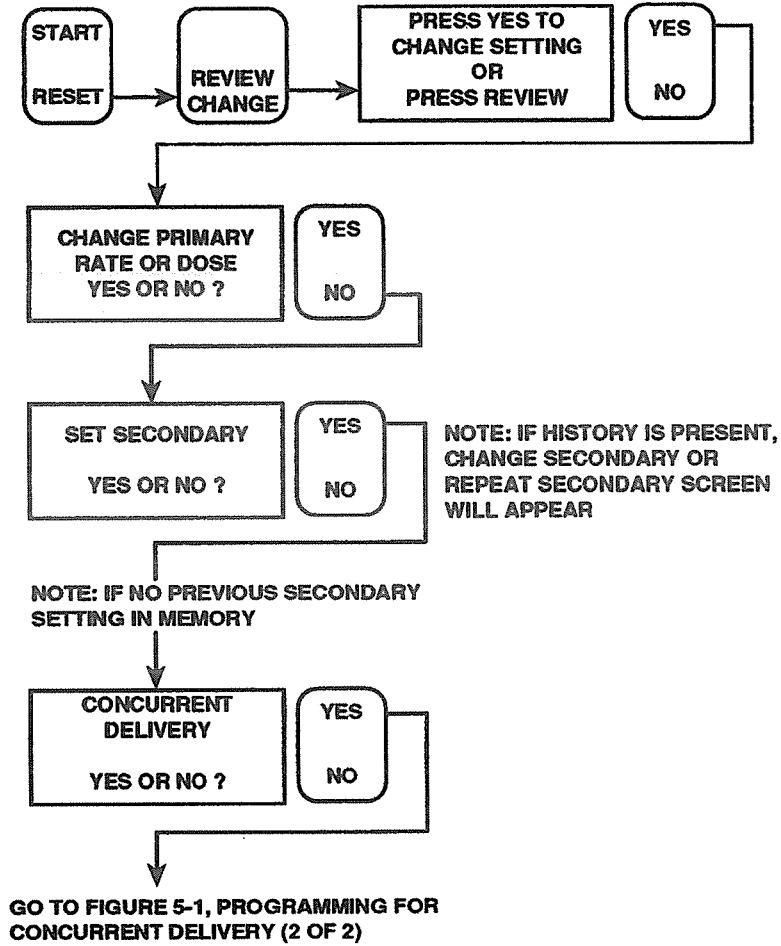

1-91-013

Figure 5-1. Programming for Concurrent Delivery (1 of 2)

CONTINUED FROM FIGURE 5-1, PROGRAMMING FOR CONCURRENT DELIVERY (1 OF 2)

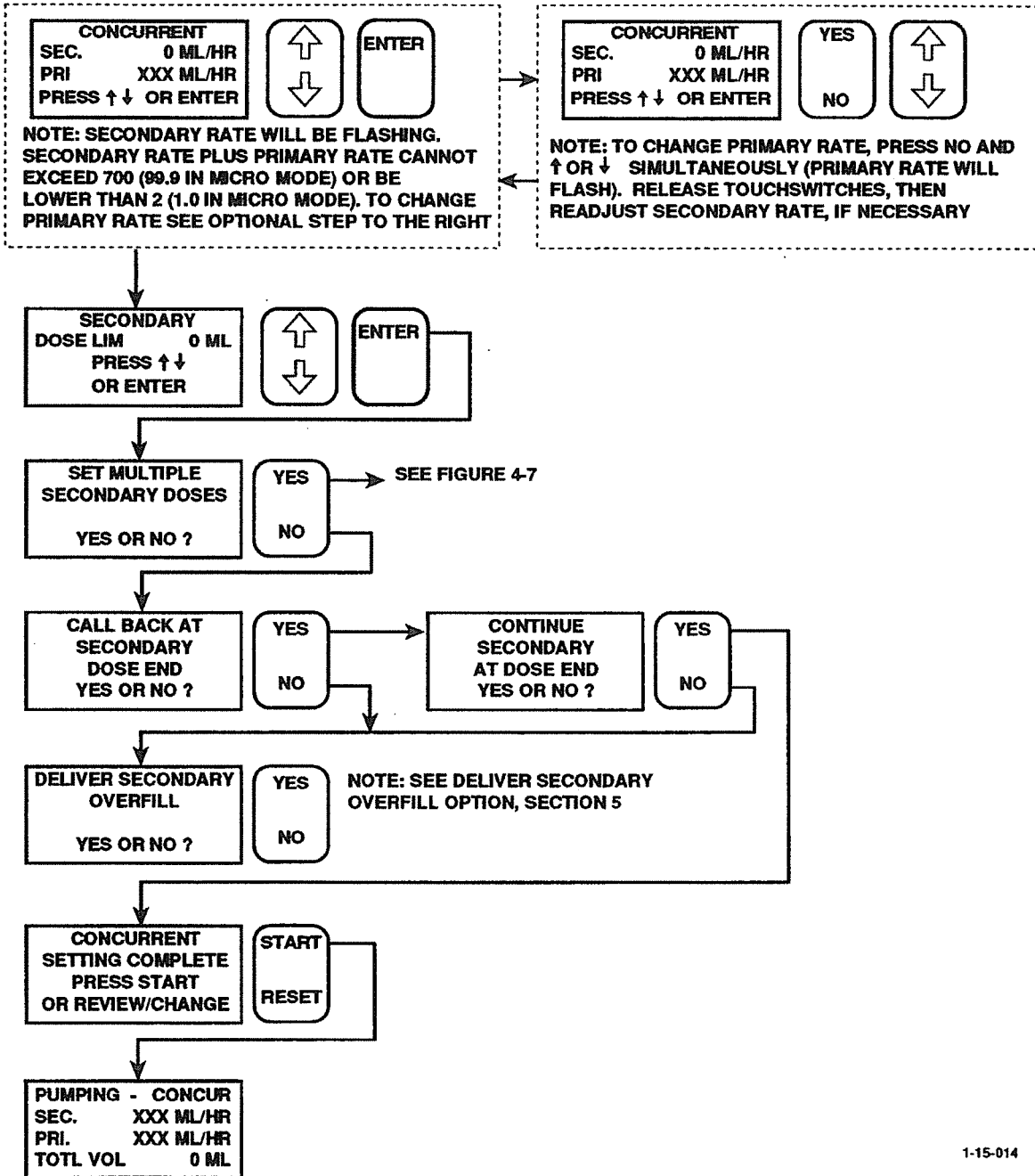

1-15-014

Figure 5-1. Programming for Concurrent Delivery (2 of 2)



CONCURRENT FLOW GUIDELINES WHEN DELIVERING CRITICAL DRUGS

Delivery Rate

When delivering short half-life critical drugs (see *Critical Drugs, this section*) using the LifeCare 5000 Version 1.6 in the concurrent mode, the following delivery rate guidelines should be observed:

- A. If the critical drug (with half-life less than 6 minutes) is to be infused at less than 2.0 mL/hr, the other infusion should be no faster than five times the critical drug's rate. Dopamine, for example, delivered at 1.5 mL/hr should not be accompanied by an infusion programmed any faster than 7.5 mL/hr.
- B. If the critical drug (with half-life less than 6 minutes) is to be infused at 2.0 to 5.0 mL/hr, the other infusion should be no faster than ten times the critical drug's rate. Dopamine, for example, delivered at 3.5 mL/hr should not be accompanied by an infusion programmed any faster than 35 mL/hr.
- C. If the critical drug (with half-life less than 6 minutes) is to be infused at 5.1 mL/hr or greater, the other infusion can be programmed at any desired rate.

Note: The total of the primary rate plus the secondary rate cannot exceed 700 mL/hr in Macro Mode or 99.9 mL/hr in Micro Mode.

These guidelines apply *only* when infusing *short half-life critical drugs* in the *Concurrent Mode*. Individual patient responses may vary, requiring adjustment of delivery rates.

Short Half-life (less than six minutes) Critical Drug Infusion Rate	Maximum Rate of Accompanying Infusion
0.5 - 1.9 mL/hr	Five Times the Critical Drug Rate
2.0 - 5.0 mL/hr	Ten Times the Critical Drug Rate
≥ 5.1 mL/hr	Any Desired Ratio

Critical Drugs

Examples of drugs with a short half-life (approximately six minutes or less when given IV) include:

- Dobutamine
- Dopamine
- Epinephrine
- Esmolol
- Isoproterenol
- Lidocaine

- Nitroglycerine
- Nitroprusside
- Norepinephrine
- Oxytocin
- Procainamide
- Trimethaphan

For these drugs, the concurrent flow guidelines should be followed when the infusion rate of the drug will be 5 mL/hr or less.

Note: This list of critical drugs is not intended to be all-inclusive of critical drugs or drugs with a short half-life.

The clinician should become familiar with the pharmacodynamics of any critical drug before administration.

USE OF NURSE CALL BACK FEATURE

When the optional Nurse Call Back feature (1.6 Series) is enabled, the Nurse Call Back alarm sounds when delivery of the secondary dose ends. This allows an opportunity to change the secondary container, if required.

When the Nurse Call Back feature is enabled, the user has the option of then allowing the pump to continue pumping secondary fluid after the Secondary Dose End.

Note: In the multidose delivery mode, if the Nurse Call Back feature is enabled, the alarm will sound at the end of every dose.

BACKPRIMING

The LifeCare 5000 Plum Infuser With DataPort offers the option of backpriming from the primary container into a secondary container, empty syringe, or vial, without opening the door. Backpriming may be used to:

- Clear air from the proximal portion and air trap of a dual-channel cassette.
- Reprime empty secondary tubing.
- Flush secondary tubing between deliveries of incompatible drugs.
- Reprime secondary containers.

Backpriming can be accomplished either manually or automatically.

Manual and auto backpriming cannot be used for clearing distal air-in-line alarms. Use standard repriming techniques for these alarms (*see Figure 4-3*).

MANUAL BACKPRIMING

The manual backpriming feature can be used safely and conveniently to clear air from the proximal portion of a dual-channel cassette (see Figures 5-2 and 5-3). Manual backpriming can also be used to reprime empty secondary tubing. Fluid volume delivered into the secondary line will be recorded on the message display, but will not be included in the total volume delivered.

Manual backpriming can be initiated in Reset Mode by simultaneously pressing and holding the [RESET] and [ENTER] touchswitches and then following the prompt messages. It is not necessary to open the door to activate this feature.

Note: To avoid pressurization when backpriming into a syringe or a vial, the user must ensure that these containers have sufficient empty space to accept the backprimed fluid.

Note: For syringes, pull up the plunger slightly before disconnecting the syringe to avoid spilling the fluid. For rigid containers (e.g., vials), open the door and remove and invert the cassette (ports down) before removing the container. This will minimize spilling of fluid during replacement of the container.

Note: Manual backpriming is not recommended for reconstituting secondary containers containing dry powders.

Note: If backpriming is not successful, make sure that the clamps on the pump set are open and/or raise the primary container or lower the secondary container, then repeat backpriming procedure.

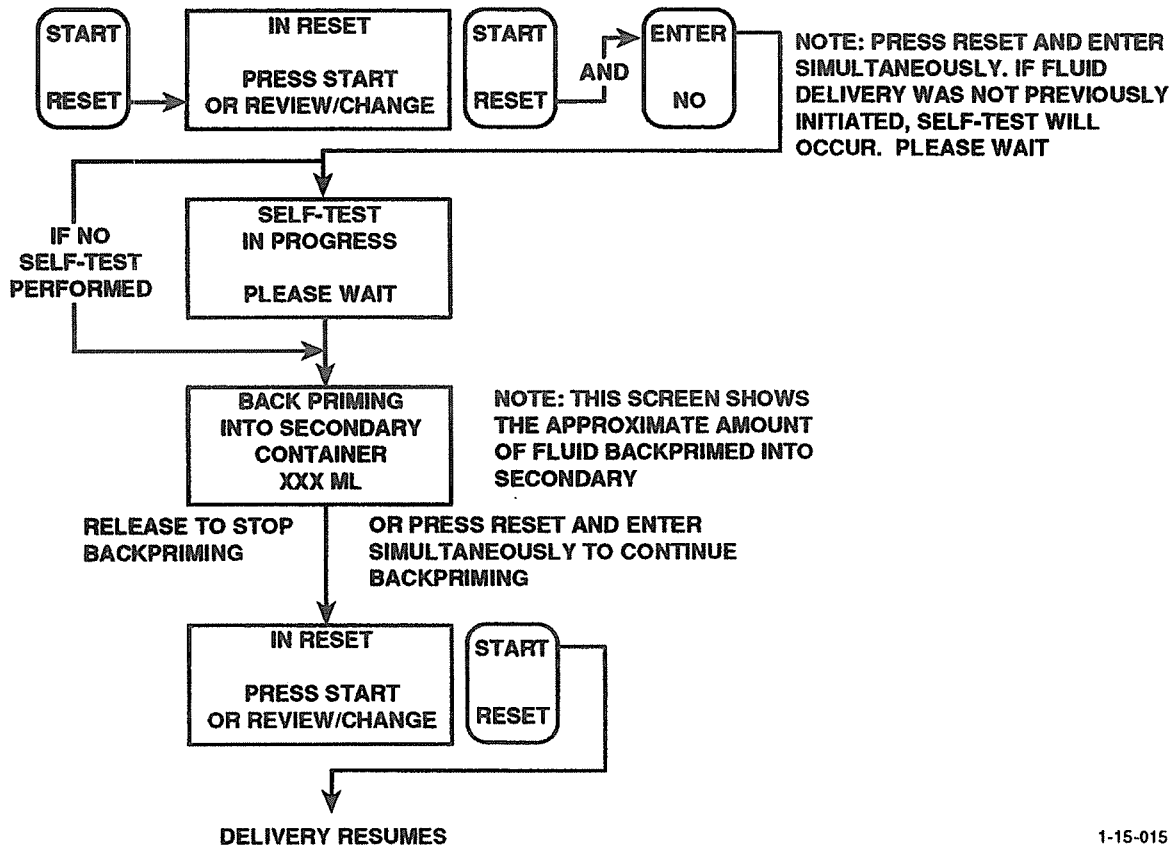

1-15-015

Figure 5-2. Manual Backpriming (Dual-Channel Cassettes Only)

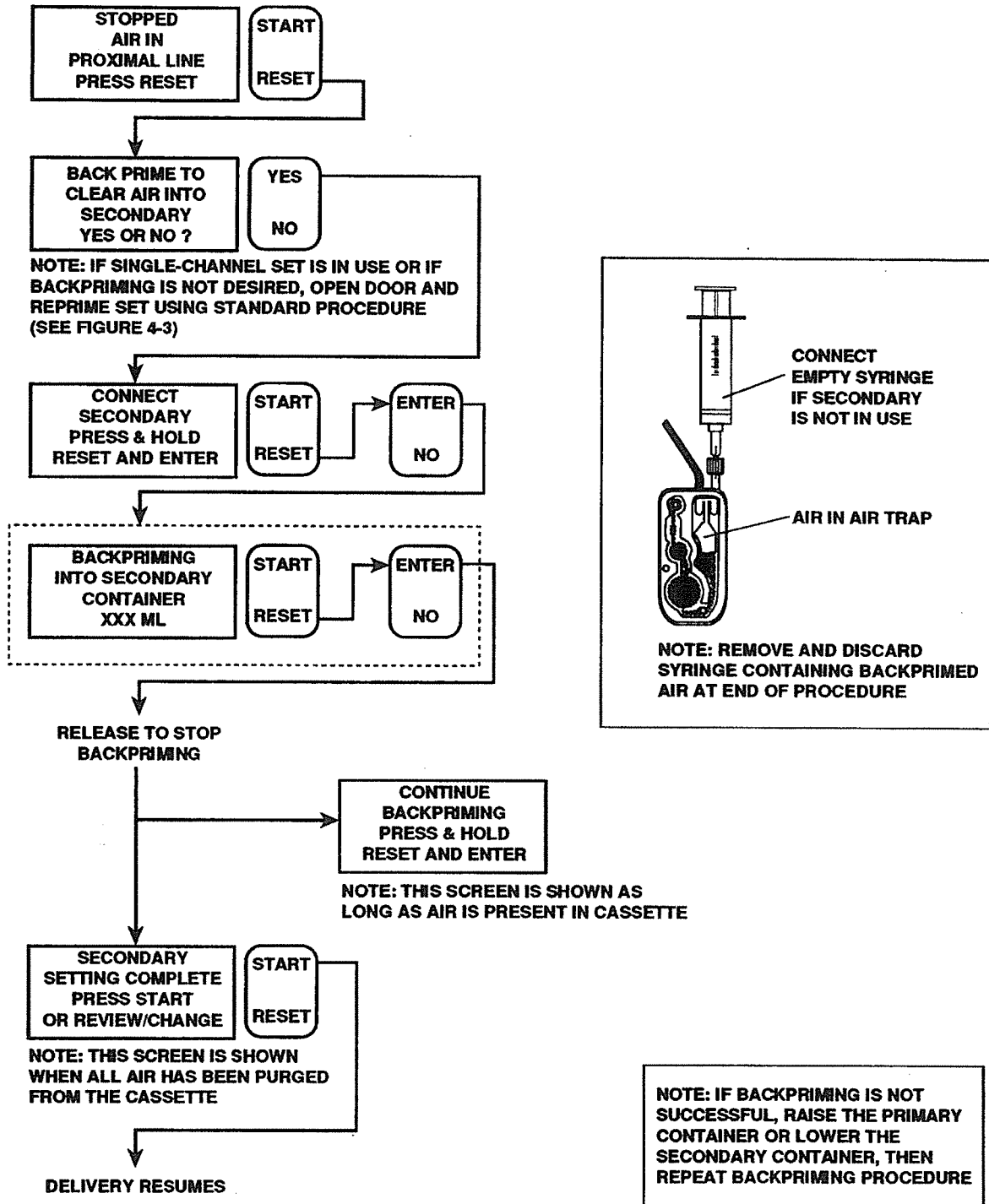

1-15-016

Figure 5-3. Clearing Proximal Air-in-Line Alarm With Manual Backpriming (Dual-Channel Cassettes Only)

AUTO BACKPRIMING

At the end of a secondary dose or the last dose in a multidose mode, the infuser may initiate an automatic backprime procedure to backprime excess accumulated air that has entered the cassette since the door was closed. This automatic feature clears only air from the cassette; backpriming of fluid is minimal. Auto backpriming reduces potential for air-in-line alarms and facilitates the DELIVER SECONDARY OVERFILL option.

DELIVER SECONDARY OVERFILL OPTION

When programming for either single dose or multiple dose secondary delivery using partfill or fullfill containers, the user may elect to use the DELIVER SECONDARY OVERFILL option to accommodate for fluid underfill or overfill of approximately 10%.

The following prompting screens will appear:

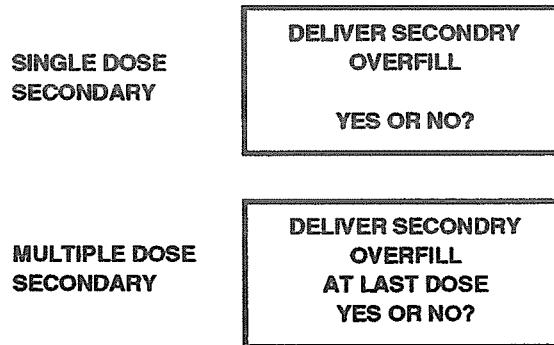

1-15-017

If [YES] is selected, the following examples describe interpretation of the dose delivered status screen:

EXAMPLE: OVERFILL

Programmed dose: 50 mL

Actual fluid volume in container (including overfill): 54 mL

At completion of dose, the dose delivered status screen will read:

SECONDARY	
DOSE LIM	50 ML
DOSE DEL	50 ML
OVERFILL	4 ML

*

1-15-018

* The total secondary volume delivered is the sum of DOSE DELIVERED and OVERFILL (54 mL in this example).

EXAMPLE: UNDERFILL

Programmed dose: 50 mL

Actual fluid volume in container: 46 mL

At completion of dose, the dose delivered status screen will read:

SECONDARY	
DOSE LIM	50 ML
DOSE DEL	46 ML
DOSE COMPLETE	

1-15-019

TITRATING

The titration feature allows the user to change delivery rates during pumping.

In Multidose Secondary Mode, the secondary rate cannot be titrated.

During multidose concurrent delivery, primary rate cannot be titrated while secondary dose is being delivered.

Note: When using the infuser for concurrent delivery of critical (short half-life) drug(s), the respective delivery rates on the primary and secondary lines should conform to the concurrent flow guidelines (see *Concurrent Flow Guidelines When Delivering Critical Drugs, this section*).

Titration Primary Rate

To titrate primary rate only:

PRESS AND HOLD NO AND ↑ OR ↓
SIMULTANEOUSLY TO CHANGE FLOW RATE

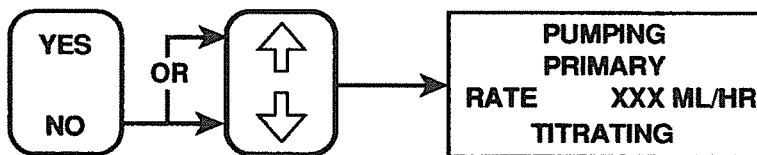

PRIMARY RATE WILL CHANGE AND REMAIN AT THE NEW
INDICATED VALUE WHEN THE TOUCHSWITCHES ARE RELEASED

1-15-020



Titrating Secondary Rate

To titrate secondary rate only:

PRESS AND HOLD YES AND ↑ OR ↓ SIMULTANEOUSLY TO CHANGE FLOW RATE

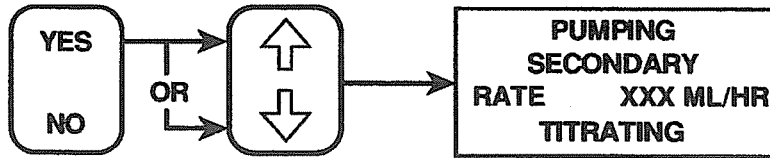

SECONDARY RATE WILL CHANGE AND REMAIN AT THE NEW INDICATED VALUE WHEN THE TOUCHSWITCHES ARE RELEASED

1-15-021

Titrating Either Primary or Secondary Rate in Concurrent Delivery

To titrate either primary or secondary rate in concurrent delivery:

PRESS AND HOLD YES AND ↑ OR ↓ SIMULTANEOUSLY TO CHANGE SECONDARY RATE

PRESS AND HOLD NO AND ↑ OR ↓ SIMULTANEOUSLY TO CHANGE PRIMARY RATE

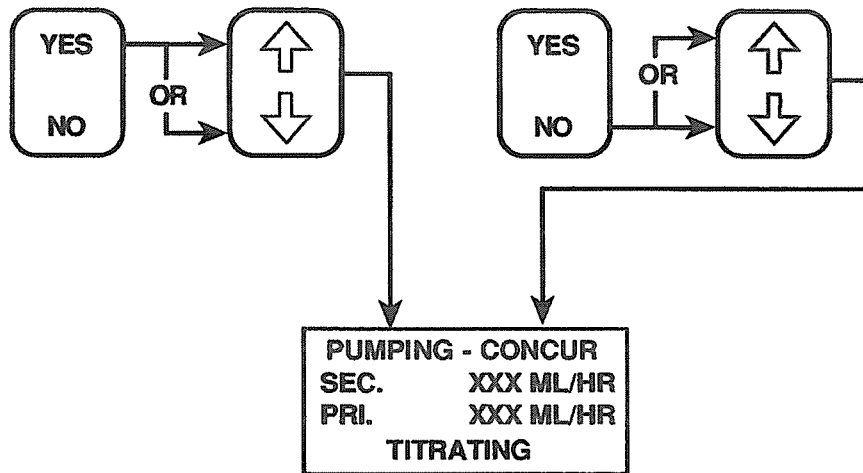

RATES WILL CHANGE AND REMAIN AT THE NEW INDICATED VALUES WHEN THE TOUCHSWITCHES ARE RELEASED

1-15-022

MUTING THE TOUCHSWITCH TONE

To avoid disturbing a patient during setup of the infuser, the user may wish to mute the audible touchswitch tone. Press [CLEAR] touchswitch to mute the tone before pressing another touchswitch. To reactivate the tone, press [CLEAR] touchswitch again or press [START] touchswitch. Tone will resume after one minute if no touchswitch is pressed.

CHANGING THE PRESSURE LIMIT

The LifeCare 5000 Plum Infusion System With DataPort monitors distal line pressure at the end of each delivery cycle. The infuser triggers an alarm if the pressure goes above set limits. The distal line pressure reading and upper limit can be reviewed by following the procedure in *Figure 4-8, Reviewing Settings*.

The upper limit for the distal line pressure is factory preset at 6 psig. The user may change this limit during initial setup of the infuser or at any other time during operation by following the procedure outlined in *Figure 5-4, Setting and Retaining Pressure Limits*. The limit can be set from 0.1 to 10.0 psig (5 to 517 mmHg) in increments of 0.1 psig. This range permits the infuser to be used in a variety of clinical situations where the monitoring and limitation of line pressure is important. The guidelines in *Table 5-2, Distal Line Pressure Limit Guidelines*, allow selection of an appropriate distal line pressure limit.

Table 5-2. Distal Line Pressure Limit Guidelines			
MAXIMUM PRESSURE LIMIT	ACCESS SITE	FLUID VISCOSITY	SETS
0.1 - 3.9 psig	Fragile Peripheral Sites	Low	Standard Administration Sets
4.0 - 5.9 psig	Peripheral Access/Central Sites	Medium	Filter Administration Sets
6.0 - 10.0 psig	Peripheral or Arterial Sites	High	Filter Administration Sets

The user may choose to retain the new pressure limit permanently (*see Figure 5-4*). If the pressure limit is not retained permanently, it will default to 6 psig after the infuser has been turned off for four hours.

NOTE: SEE FIGURE 4-10, CLEARING SETTINGS, TO REACH THE FIRST SCREEN

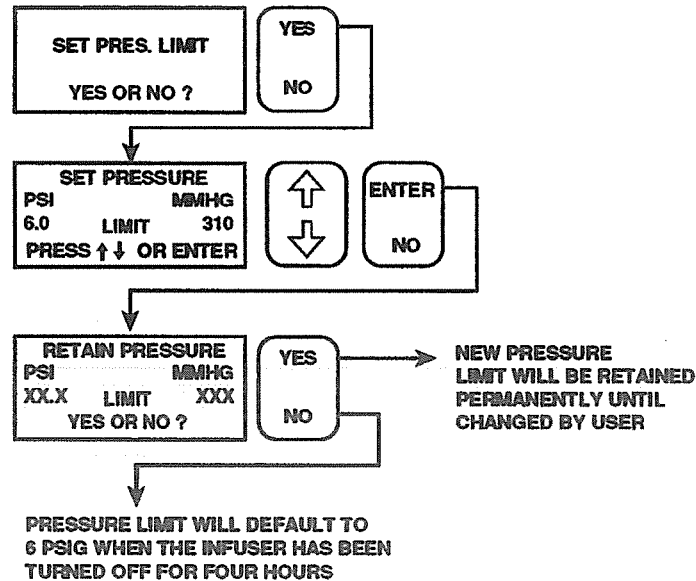

1-15-023

Figure 5-4. Setting and Retaining Pressure Limits

USING RETROGRADE PROCEDURES

See *Figure 5-5, Using Retrograde Procedure*, for instructions on retrograde administration of small volumes of compatible medications.

Note: For retrograde procedures, use any suitable PlumSet administration set with two distal Y-sites, e.g., List Numbers 6488, 6433, 6445, etc. See *Administration Sets and Accessories, Section 9*, or see set carton labeling for retrograde volume contained between the Y-sites.

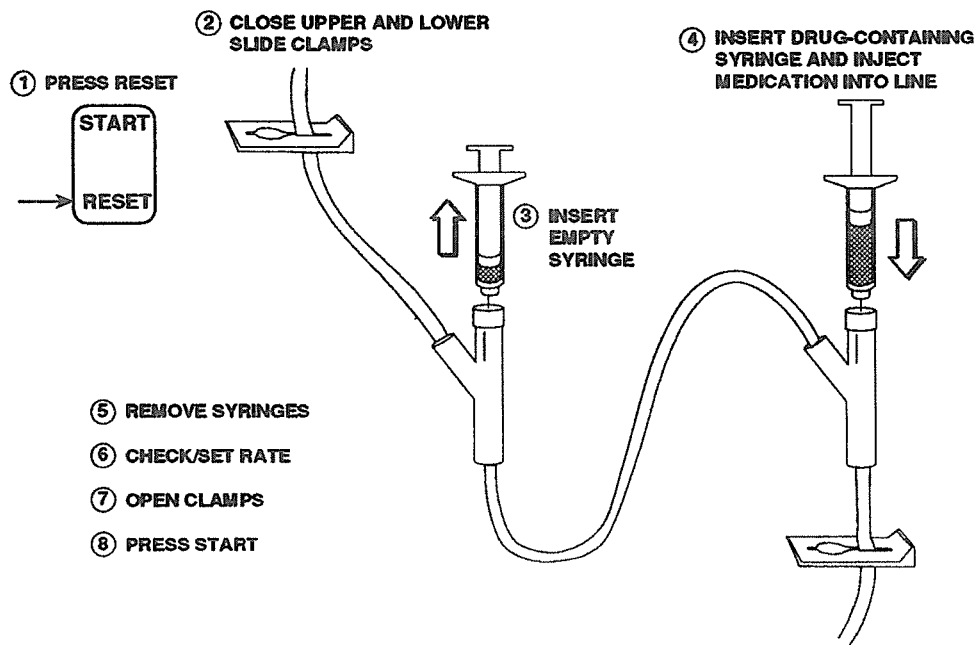

Figure 5-5. Using Retrograde Procedure

USING SYRINGES, VIALS, OR OTHER CONTAINERS FOR SECONDARY ADMINISTRATION

CAUTION: Before attempting to fit a syringe or vial into the infuser, confirm that drug concentrations, delivery rates, and volumes are suitable for secondary infusion (see drug container labeling).

Note: When delivering in Single Dose Secondary or Multiple Dose Secondary (Dual-Channel) Mode, use an 18- or 19-gauge needle with a maximum length of 1-1/4" to avoid bottoming needle in secondary port well when piercing reseal.

When the above precautions are observed, the following conventional IV syringes or vials may be used with the infuser for secondary drug administration:

- Syringes 10 cc or larger can be attached directly to the secondary port of the cassette.
- Syringes smaller than 10 cc, or 60 cc and larger **require** the use of a special vented syringe adapter, List Number 9292.
- Syringes smaller than 3 cc should not be used.
- Vials **require** the use of a special vented vial adapter, List Number 9293.
- Use suitable secondary IV set with other secondary containers.

Note: Before attaching a secondary container to the cassette, make certain that the air trap is full of liquid. If air is present, remove it using manual backpriming (see *Figure 5-3*).

Any secondary container can be attached to the cassette without opening the door.

Syringes 10 cc or larger

When administering fluids using syringes 10 cc or larger, proceed as follows:

1. Prepare IV syringe using aseptic technique.
2. Invert the syringe and expel the excess air, if any.
3. Attach 19-gauge by 1-1/4" or larger needle to the syringe port or connect directly to capped port.
4. Invert the syringe and insert into the reseal port of the dual channel cassette; or attach directly to the secondary port if the cassette has no reseal.
5. Secure the syringe to the door with the container support, List Number 9294.
6. Press [RESET] touchswitch and follow display prompts described in *Figure 4-6, Programming for Single Dose Secondary Delivery*.

Syringes 5 cc to 3 cc

The previous steps also apply to syringes 3 cc to 5 cc, with the following conditions:

1. Attach syringe adapter to the syringe and prime by inverting and actuating plunger.
2. Before starting secondary delivery, retract the syringe plunger to introduce approximately 1 mL of air into the syringe. This will clear the liquid from the adapter filter and help vent the syringe during delivery.

Vials

To administer fluids using vials, proceed as follows:

1. Spike the vial cap with the vial adapter.
2. Invert and attach to the secondary port of the cassette either directly or through the 19-gauge by 1-1/4" or larger needle.
3. Press [RESET] touchswitch and manually backprime air out of the vial adapter. This is necessary since the vial is rigid, and air cannot be removed by manipulating the plunger.

The infuser will appear as shown in *Figure 5-6, Using Infuser With Secondary Line, Syringe, or Vial*, properly fitted with either a compatible syringe or vial. The use of a secondary container support, List Number 9294 (not shown), is recommended to secure syringes or vials to the Infuser door.

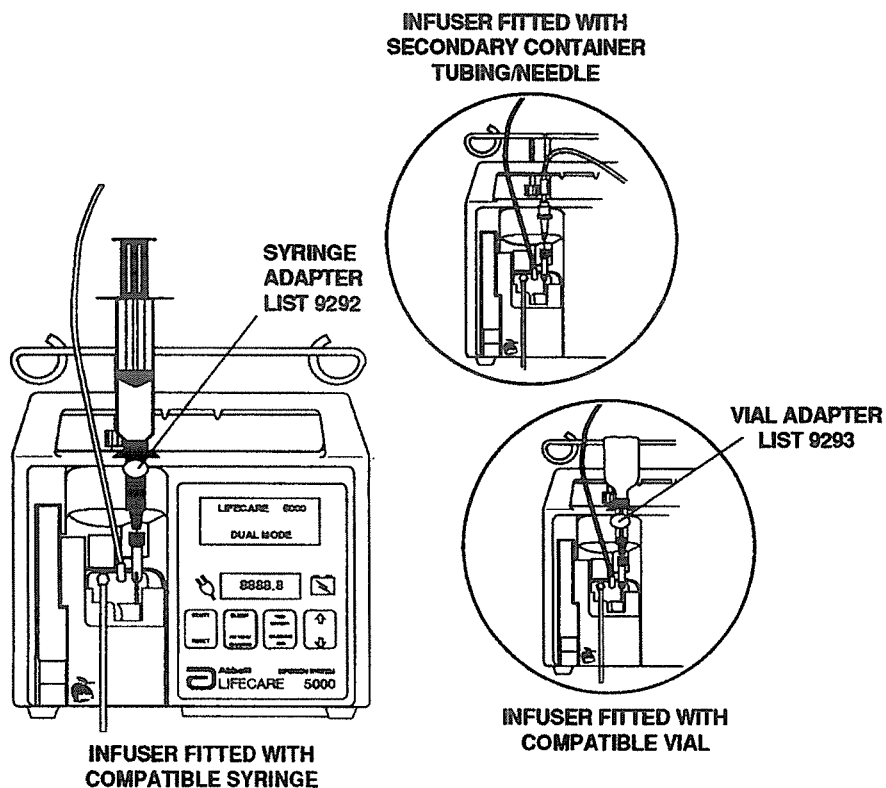

Figure 5-6. Using Infuser With Secondary Line, Syringe, or Vial

Section 6

ALARMS AND TROUBLESHOOTING

The LifeCare 5000 Plum Infusion System With DataPort warns the operator of problems that may affect fluid delivery or proper operation of the equipment. If an alarm condition is signaled, proceed as follows:

1. Press [SILENCE] touchswitch
2. Identify alarm message
3. Press [RESET] touchswitch
4. Correct the condition
5. Press [START] touchswitch

Note: If the MALFUNCTION ALARM repeats, the operator should discontinue use of the infuser.

Manual and auto backpriming cannot be used for clearing distal air-in-line alarms. Use standard repriming techniques for these alarms (see *Figure 4-3*).

REVIEWING PREVIOUS ALARMS

As a convenient indicator of alarm cause, the infuser automatically records the previous 15 alarm conditions expressed as alarm codes (see *Figure 6-1, Accessing the Alarm History*).

INSERT CASSETTE. CLOSE DOOR. PRESS AND HOLD REVIEW.

WHEN "SELF TEST : OK" APPEARS, RELEASE TOUCHSWITCH, THEN PRESS AND HOLD REVIEW

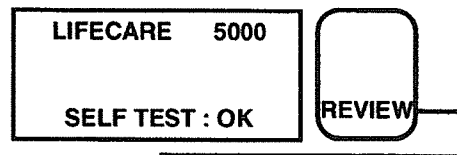

WHEN "REV X.XX" APPEARS, RELEASE TOUCHSWITCH, THEN PRESS AND HOLD REVIEW

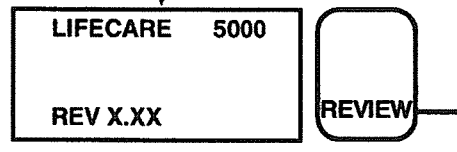

HOLD REVIEW TO READ ALARM HISTORY. THE MOST RECENT ALARM CODE APPEARS AT THE LOWER RIGHT OF SCREEN

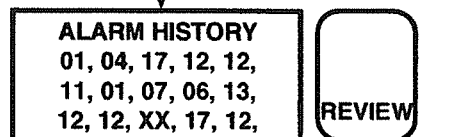

1-15-024

Figure 6-1. Accessing the Alarm History



Common alarm codes are listed and explained in *Table 6-1, Alarm/Action Table*, along with appropriate corrective actions to be taken.

Table 6-1. Alarm/Action Table			
ALARM MESSAGE	ALARM CODE	POSSIBLE CAUSE	CORRECTIVE ACTION
STOPPED DISTAL LINE OCCLUSION	01	Distal line kinked, distal clamp clotted; IV site	Examine distal line for kinks or internal obstructions
		Pressure limit set too low	Reset pressure limit
		Infuser positioned incorrectly	Reposition infuser at or above mid-axillary line of patient
STOPPED PROX. OCCLUSION (PRIMARY OR SECONDARY)	03	Proximal line obstructed	Examine line for kinks, closed clamps or internal obstructions. Check to be sure 19-gauge or larger needle is used
		Secondary container not connected	
		Wrong administration set	Replace with -02 series set with flow regulator
STOPPED PRESSURE OUT OF RANGE	05	Single-channel cassette used for dual-channel delivery	Replace with dual-channel cassette
		Distal line pressure outside normal range	Position infuser at mid-axillary line of patient
STOPPED AIR IN PROXIMAL LINE	06	Defective cassette	Replace set if repeats. If recurs, discontinue use of infuser
		Air has been detected in cassette proximal line during pumping due to: <ul style="list-style-type: none"> - Empty container - Cumulative air-in-line volume exceeded due to outgassing or successive air segments introduced by underfilled secondaries - Damaged cassette or adapter - Proximal line occluded 	Reprime cassette using standard techniques when using a single channel cassette If using a dual-channel cassette, follow the special backpriming technique shown in <i>Figure 5-3</i> ; or use standard repriming techniques

Table 6-1. Alarm/Action Table			
ALARM MESSAGE	ALARM CODE	POSSIBLE CAUSE	CORRECTIVE ACTION
STOPPED AIR IN DISTAL LINE	07	Air has been detected in cassette distal line due to: <ul style="list-style-type: none"> - Excessive air in air trap - Incomplete priming - Outgassing - Damaged cassette 	Reprime cassette using standard techniques. If alarm repeats, replace set If damaged, replace cassette
BACK PRIME TO CLEAR AIR INTO SECONDARY	08	Air has been detected in cassette air-trap chamber	Reprime cassette using standard techniques when using a single channel cassette If using a dual-channel cassette, follow the special backpriming technique shown in <i>Figure 5-3</i> ; or use standard repriming techniques
EMPTY CONTAINER PRIMARY/KVO* <small>*An empty container can only be detected by using a flow detector.</small>	09	Empty container on primary line Occluded primary proximal line Flow detector connected but not attached to the primary drip chamber Overfilled drip chamber	Replace with new container on primary line Clear cause of alarm Attach flow detector to the primary drip chamber
STOPPED FOR 5 MINUTES	11	Pump has been in RESET for five minutes and a key has not been depressed in one minute	Press [RESET]. Complete set-up and/or press [START], or open door and remove cassette
DOSE END/KVO	12	Primary dose has been completed	Discontinue delivery or set another primary dose
LOW BATTERY PLUG PUMP INTO AC CIRCUIT IMMEDIATELY	17	Battery has nearly discharged	Connect infuser to AC power
STOPPED SYSTEM RETEST REQUIRED	13, 14 15, 16	Faulty or damaged cassette Proximal or distal occlusion or air in cassette detected at start up	Open all clamps. Prime out excess air. Close door to retest. If repeats, discontinue use of infuser

Table 6-1. Alarm/Action Table			
ALARM MESSAGE	ALARM CODE	POSSIBLE CAUSE	CORRECTIVE ACTION
STOPPED DEAD BATTERY	18	Battery is fully discharged	Connect infuser to AC power
STOPPED DOOR OPENED WHILE PUMPING	19	Door has been opened while unit is pumping	Close door. Press [RESET] and [START] to resume
MALFUNCTION CODE	XX	A failure has occurred in the infuser internal systems	Note malfunction code, open, then close door. If alarm repeats, remove infuser from service
FLOW DETECTOR CONNECTED	0B	Flow detector connected while the infuser is pumping	Press [RESET] to silence the alarm, and [START] to resume delivery
CONNECT FLOW DETECTOR	0A	Flow detector disconnected while infuser is pumping	<ol style="list-style-type: none"> 1. Press [RESET] 2. Reconnect flow detector and press [START] or <ol style="list-style-type: none"> 1. Press [RESET] 2. Enter a dose limit 3. Press [START]

Section 7

OPERATIONAL PRECAUTIONS

The LifeCare 5000 Infusion System has been designed and manufactured to be safe, reliable, and easy to use. However, for safest operation, the following precautions should be observed.

Nonhazardous, low level electrical potentials are commonly observed when fluids are administered using infusion devices. These potentials are well within accepted safety standards, but may create artifacts on voltage sensing equipment such as ECG, EMG, and EEG machines. These artifacts vary at a rate that is associated with the infusion rate. If the monitoring machine is not operating correctly or has loose or defective connections to its sensing electrodes, these artifacts may be accentuated so as to simulate actual physiological signals. To determine if the abnormality in the monitoring equipment is caused by the infusion device instead of some other source in the environment, set the infusion device so that it is temporarily not delivering fluid. Disappearance of the abnormality indicates that it was probably caused by the electronic noise generated by the infusion device. Proper setup and maintenance of the *monitoring equipment* should eliminate the artifact. Refer to the appropriate monitoring equipment system documentation for setup and maintenance instructions.

Checkout should be performed by qualified personnel only.

If the flow detector is not connected and a dose limit is not set, the LifeCare 5000 Infuser will not start delivery.

Product damage may occur unless proper care is exercised during the unpacking and installation process. The battery may not be fully charged upon receipt. Possible induced hazards to operating personnel or to patients will be detected by the infuser Self-Test.

Do not place infuser in service until the infuser Self-Test has been conducted. The Self-Test procedure should be performed by qualified personnel only.

Use AC power whenever possible. Plug in infuser during storage to ensure a fully-charged battery for emergencies. If quality of earth grounding source is in doubt, use battery power.

Arrange tubing, cords, and cables to minimize the risk of patient strangulation or entanglement.

Only use compatible Plum 1.6 administration sets. These sets are designed for delivering concurrent flow and are the only sets that can be used with the infuser (1.6 Series). See individual set instructions for additional information.

When delivering in Multiple Dose Secondary (Dual-Channel) Mode, be sure that the total volume in the multidose secondary container at least equals total required volume as determined by volume per dose times the number of prescribed doses.

Before opening door, close clamp on secondary set or remove secondary container from secondary port to prevent mixing of primary and secondary fluids.

Variation in patient response may occur with certain drugs with short half-life. Variations can be avoided by either maintaining a flow rate of greater than 5 mL/hr for the short half-life drug or by ensuring that the rates on the concurrent infusions conform to the concurrent flow guidelines (see *Concurrent Flow Guidelines When Delivering Critical Drugs, Section 5*).

When using the infuser for concurrent delivery of primary and secondary fluids, confirm that the drugs/fluids being administered are chemically and physically compatible.

In the multidose delivery mode, if the Nurse Call Back feature is enabled, the alarm will sound at the end of every dose.

Following completion of the primary dose (Concurrent Mode), the screen prompt CONCURRENT SETTING COMPLETE indicates that the unit will complete the pre-existing setup. The infuser switches to *primary only delivery* when the secondary dose is complete (or switches immediately to primary if the doses complete simultaneously). Use of the Nurse Call Back option is recommended when critical drugs are delivered.

To avoid pressurization when backpriming into a syringe or a vial, the user must ensure that these containers have sufficient empty space to accept the backprimed fluid.

Before disconnecting the syringe, pull up the plunger slightly to avoid spilling the fluid. For rigid containers (e.g., vials), open the door and remove and invert the cassette (ports down) before removing the container. This will minimize spilling of fluid during replacement of the container.

Backpriming is not recommended for reconstituting secondary containers containing dry powders.

If backpriming is not successful, make sure that the clamps on the pump set are open and/or raise the primary container or lower the secondary container, then repeat backpriming procedure.

When using the infuser for concurrent delivery of critical (short half-life) drug(s), the respective delivery rates on the primary and secondary lines should conform to the concurrent flow guidelines (see *Concurrent Flow Guidelines When Delivering Critical Drugs, Section 5*).

For retrograde procedures, use any suitable PlumSet administration set with two distal Y-sites, e.g., List Numbers 6488, 6433, 6445, etc. See *Administration Sets and Accessories, Section 9*, or set carton labeling for retrograde volume contained between the Y-sites.

Before attempting to fit a syringe or vial into the infuser, confirm that drug concentrations, delivery rates, and volumes are suitable for secondary infusion (see drug container labeling).

Before attaching a secondary container to the cassette, make certain that the air trap is full of liquid. If air is present, remove using manual backpriming (see *Figure 5-3*).

When using the LifeCare 5000 Plum Infuser With DataPort for concurrent delivery of primary and secondary fluids, the user must be aware of the following issues:

- It must be confirmed that the drugs/fluids being administered are chemically and physically compatible.

-
- ❑ Administration and therapeutic effect of drugs with a short half-life relative to peak-to-peak time in the concurrent mode at certain ratios must be closely monitored by a clinician knowledgeable about the pharmacokinetics of the drugs involved.
 - ❑ When critical drugs with short half-life are being administered using concurrent delivery, the respective flow rates on the primary and secondary lines should conform to the concurrent flow guidelines (see Table 5-1).

Suspend the container above, but not directly over, the infuser. The infuser should be at, or slightly above, the level of the patient.

At initial start up, confirm mode identification.

In Dual-Channel Mode, setting the primary rate greater than the secondary rate will result in a more rapid infusion of any residual secondary drug remaining in the line and the cassette.

Use 19-gauge or larger needle for viscous fluids if operating at rates greater than 500 mL/hr. A higher pressure setting is also recommended.

When connecting to a reseat, use a 1-1/4" or shorter, 19-gauge needle to connect a secondary line to the secondary port of dual-channel cassette to avoid bottoming needle tip in well, or use capped secondary port when not using a needle for administration.

As a last step before pressing [START] touchswitch, review settings and be sure the proximal and distal line clamps are both open.

Always connect the infuser to a properly grounded, hospital-grade receptacle, unless battery operation is desired. If a properly grounded AC line source is in doubt, use battery power.

When a cassette is properly inserted and the doorlatch closed, a completely blank front panel (no lights, symbols, messages) indicates that the battery is depleted and the device is not plugged into a live AC circuit. If the infuser cannot be plugged into an AC circuit, it cannot be used.

Never use sharp objects such as pens, pencils, fingernails, paperclips, etc., to press the touchswitches on the infuser. Doing so will seriously damage the switch elements and prevent proper operation of the infuser.

Only LifeCare 5000 PlumSet administration sets can be used.

Sets should be changed in accordance with current, recognized guidelines of IV therapy. Discard per hospital procedures.

LifeCare IV infusion sets with integral IVEX[®]-II or -HP filter are not for use in the administration of blood, blood products, emulsions, suspensions, or any medications not totally soluble in solution being administered. These medications may be administered through the lower Y-injection site, below the filter.

In vitro studies have suggested that packed red blood cells with unusually high hematocrit be diluted with blood-compatible fluids, such as 0.9% Sodium Chloride Injection, USP, to decrease hemolysis and increase flow rate.

Using the DELIVER SECONDARY OVERFILL option and an underfilled container, the device will automatically revert to primary, provided the container volume is at least 90% of the dose selected.



The use of appropriate PlumSets with microbore tubing is recommended for low flow rates (1 mL/hr or less). Under such usage, delivery accuracy may be affected if air bubbles are not carefully primed from pumping chamber or distal tubing and when the infuser is used in the presence of elevated backpressure or mounted significantly above the patient. To minimize potential for air bubble formation due to outgassing effects, mount infuser near the level of the patient.

A small amount of fluid is expelled from the set (less than 0.1 mL) each time the door is opened or closed with a set installed. If potent drugs are being used, take appropriate action to guard against overmedication of the patient.

Repeated opening and closing of the door may defeat the proximal air-in-line alarm and may cause a distal air-in-line alarm, requiring standard repriming.

Repeated opening and closing of the door may cause the drip chamber to over-fill.

Do not operate the infuser with the case opened.

Do not immerse the infuser in fluids of any kind.

Some cleaning and sanitizing compounds may slowly degrade components made from some plastic materials. Using abrasive cleaners or cleaning solutions not recommended by Abbott Laboratories may result in product damage. Do not use compounds containing combinations of isopropyl alcohol and dimethyl benzyl ammonium chloride.

Possible explosion hazard exists if used in the presence of flammable anesthetics.

Section 8

MODE CONFIGURATION, MAINTENANCE, AND CLEANING

MODE CONFIGURATION

The LifeCare 5000 Plum Infuser With DataPort is designed so that it can be configured as a Micro or a Macro infuser by means of internal DIP switches. These DIP switches also enable or disable dual-channel, and multidose operation. The DIP switch can be set only by qualified hospital technical personnel.

MAINTENANCE

There are no routine calibration or adjustment procedures required for use of this infuser. There are no user serviceable parts. All servicing or adjustments of the LifeCare 5000 Plum Infusion System With DataPort should be referred to qualified technical personnel. A Technical Service Manual may be ordered from the Abbott Laboratories Technical Service Center.

BATTERY MAINTENANCE

The infuser can be battery powered for emergency backup and temporary portable operation. A fully charged new battery will provide approximately 500 mL total volume delivered or six hours of operation, whichever occurs first.

CAUTION: If the PLUG INTO AC CIRCUIT IMMEDIATELY alarm sounds, immediately plug the pump into AC power.

The battery can be recharged by connecting the line cord to a hospital-grade, 117 VAC receptacle. After a full discharge, recharge of the battery to 80% of prior capacity takes at least 16 hours.

As a general rule, the more often the battery is discharged and recharged, the sooner it will need to be replaced. Consult your qualified hospital maintenance personnel for replacement of the battery as necessary.

To maintain maximum battery charge and to prolong battery life, keep the line cord connected to AC power whenever possible.

CLEANING

CAUTIONS:

To avoid mechanical or electronic damage, do not immerse the infuser in any fluids or cleaning solutions.

Some cleaning and sanitizing compounds may slowly degrade components made from some plastic materials. Using abrasive cleaners or cleaning solutions not recommended by Abbott Laboratories may result in product damage. Do not use compounds containing combinations of isopropyl alcohol and dimethyl benzyl ammonium chloride.

Do not sterilize by heat, steam, ETO, or radiation.

Establish a routine schedule for cleaning the infuser.

To clean the infuser:

- Turn off infuser and disconnect power cord.
- Clean the exposed surfaces of the infuser with a soft, lint-free cloth dampened with one of the cleaning solutions listed in *Table 8-1, Cleaning Solutions*. Unit is not affected by fluid spills or cleaning solutions.

Do not use abrasive cleaners on the infuser or flow detector.

Cleaning Solution	Manufacturer	Preparation
Cidex®	Arbrook Laboratories	Per manufacturer's recommendation
Vesphene® II se	Calgon Vestal Laboratories	Per manufacturer's recommendation
Super Edisonite®	S. M. Edison Chemical Co.	Per manufacturer's recommendation
Household bleach	Various	One part bleach in four parts water
Manu-Klenz®	Calgon Vestal Laboratories	Per manufacturer's recommendation
Formula C™	DuBois Chemicals	Per manufacturer's recommendation

All elements behind the cassette door should be cleaned on a routine basis with cotton-tipped swabs saturated with cleaning solution.

The cassette door can be disconnected from the doorlatch by pressing door release tab as shown in *Figure 8-1, Cleaning the Mechanical Elements Behind Cassette Door*, so that the receptacle may be easily accessed for thorough cleaning as necessary.

Note: Never use sharp objects such as pens, pencils, fingernails, paperclips, needles, etc., to clean area behind the cassette door.

The flow detector may be cleaned with a soft cloth dampened with alcohol or soapy water. The plastic windows through which drops are detected should be carefully swabbed with a cotton swab dipped in alcohol, then dried.

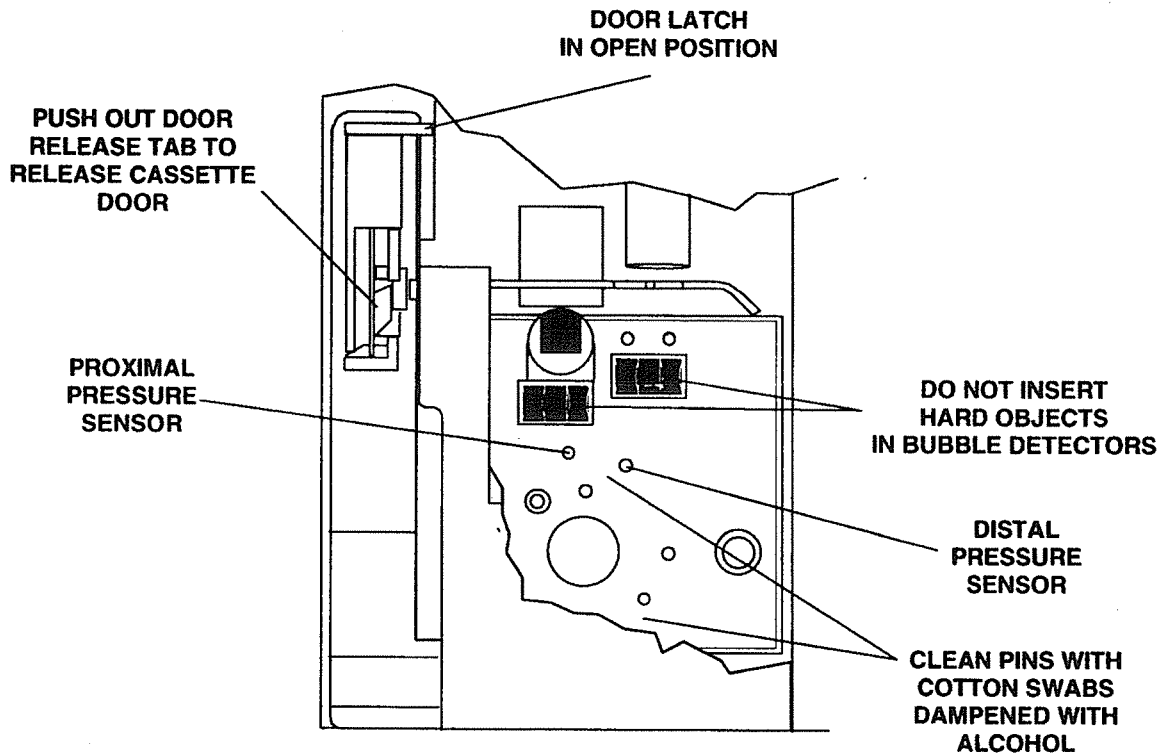

Figure 8-1. Cleaning the Mechanical Elements Behind Cassette Door

This page intentionally left blank.

Section 9

ADMINISTRATION SETS AND ACCESSORIES

The following PlumSet administration sets and accessories are available for use with the LifeCare 5000 Infuser. The administration sets are supplied STERILE and are for SINGLE USE ONLY.

Note: Only use administration sets with the list numbers ending in -02. These sets are designed for delivering concurrent flow and are the only sets that can be used with the Plum Infuser (1.6 Series).

PLUMSETS

SINGLE-CHANNEL SETS

Nutritional Sets

- List 1479-02: 40 mm Screw Cap Single-Channel Infusion Set. 98-inch (249 cm) screw cap set with bacterial retentive air filter and inline cassette. Universal catheter adapter fits feeding tubes 5 Fr. to 20 Fr.
- List 6437-02: Modified Screw Cap Single-Channel Infusion Set. 98-inch (249 cm) screw cap set with bacterial retentive air filter and inline cassette. Universal catheter adapter fits feeding tubes 5 Fr. to 20 Fr. For use with Aqualite[®] container system.
- List 6492-02: Single-Channel Enteral Infusion Set with Integral Container. 102-inch (259 cm) enteral set with integral empty 1 liter flex container and inline cassette. Special enteral catheter adapter with Luer Taper fits tubes 2 Fr. to 20 Fr.



DUAL-CHANNEL SETS

General IV Administration Sets

- List 1735-02: Nonvented Microdrip Dual-Channel Infusion Set. 104-inch (264 cm) IV set with inline dual-channel cassette, Y-injection site, and Secure Lock.
- List 6426-02: Vented Dual-Channel Infusion Set. 104-inch (264 cm) IV set with dual-channel inline cassette, Y-injection site, and Secure Lock.
- List 6432-02: Nonvented Dual-Channel Infusion Set. 104-inch (264 cm) IV set with dual-channel inline cassette, Y-injection site, and Secure Lock.
- List 6480-02: Vented Dual-Channel Infusion Set with Capped Secondary Port. 104-inch (264 cm) IV set with dual-channel cassette, Y-injection site, and Secure Lock.
- List 11179-02: Nonvented Dual-Channel Infusion Set with IVEX-2 Micron Filter. 112-inch (284 cm) IV set with inline cassette and inline proximal IVEX-2 filter, Y-injection site, and Secure Lock.

Integral IVEX-HP Filter Sets

- List 6427-02: Vented Dual-Channel Infusion Set with IVEX-HP 0.22 Micron Filter. 112-inch (284 cm) IV set with dual-channel inline cassette and inline IVEX-HP filter, two lower Y-injection sites, and Secure Lock.
- List 6445-02: Vented Dual-Channel Infusion Set with Vented Soluset[®] 150 x 15 and IVEX-HP 0.22 Micron Filter. 130-inch (330 cm) Soluset with 150 mL chamber, inline cassette, three Y-injection sites, inline IVEX-HP filter, 7.8 mL retrograde volume, and Secure Lock.
- List 9291-02: Vented Dual-Channel Infusion Set with Soluset Microdrip 150 x 60 and IVEX-HP 0.22 Micron Filter. 139-inch (353 cm) length. A 150 mL calibrated burette microdrip set for admixture or volume restriction with three Y-injection sites, 0.22 micron IVEX-HP pediatric filter, microbore tubing, and Secure Lock. Retrograde volume 2.9 mL.

Burette-Type Sets

- List 2424-02: Nonvented Dual-Channel Infusion Set with Soluset 150 x 60 Microdrip. 124-inch (315 cm) dual-channel inline cassette, two Y-injection sites and Secure Lock.
- List 6428-02: Vented Dual-Channel Infusion Set with Vented Soluset 150 x 60. 124-inch (315 cm) length. A 150 mL calibrated burette set for admixture or volume restriction with two distal Y-injection sites, microbore tubing, and Secure Lock. Retrograde volume 2.9 mL.
- List 6433-02: Vented Dual-Channel Infusion Set with Vented Soluset 150 x 15. 114-inch (290 cm) Soluset with 150 mL chamber, dual-channel inline cassette, two Y-injection sites approximately 8" and 69" from needle adapter, 7.8 mL retrograde volume, and Secure Lock.

- List 6436-02: Vented Dual-Channel Infusion Set with Vented Soluset 150 x 60. 105-inch (267 cm) burette set with 150 mL chamber, inline cassette, microbore tubing with no Y-injection sites, and Secure Lock. Priming volume of distal set 2.75 mL.
- List 6446-02: Vented Microdrip Infusion Set with Vented Soluset 50 x 60. 105-inch (267 cm) length. A 50 mL calibrated burette microdrip set for admixtures or volume restriction with two distal Y-injection sites for retrograde procedures; with microbore tubing and Secure Lock. Retrograde volume 2.5 mL.
- List 9290-02: Vented Dual-Channel Infusion Set with Capped Secondary Port and Soluset 150 x 60 Microdrip. 124-inch (315 cm) dual-channel inline cassette with two Y-injection sites and Secure Lock.
- List 9291-02: Vented Dual-Channel Infusion Set with Soluset 150 x 60 Microdrip and IVEX-HP Filter. 139-inch (353 cm) dual-channel set for admixture or volume restriction. 150 mL chamber, inline cassette, 0.22 micron IVEX-HP Pediatric filter, microbore tubing, three Y-injection sites, and Secure Lock. Retrograde volume 2.9 mL.

HEMA® Blood Administration Sets

- List 11234-02: Vented Dual-Channel Infusion Set (Y-type). 121-inch (307 cm) blood pump set with high capacity, bucket-type nylon blood filter, one vented and one nonvented piercing pin, inline cassette, and Secure Lock.
- List 11235-02: Nonvented Dual-Channel Infusion Set. 110-inch (279 cm) blood pump set with high capacity, bucket-type nylon blood filter, inline cassette, lower Y-injection site, and Secure Lock.

MB-Type Sets

- List 6497-02: Nonvented Dual-Channel Infusion Set with MB Pin. 107-inch (272 cm) set with Y-injection site.
- List 6498-02: Nonvented Dual-Channel Infusion Set with IVEX-HP 0.22 Micron Filter and MB Pin. 114-inch (290 cm) set with two Y-injection sites, inline IVEX-HP filter, and Secure Lock.

Specialty Sets

- List 2422-02: Specialty Microbore Dual-Channel PlumSet. 76-inch (193 cm) length.
- List 2423-02: Specialty Microbore Dual-Channel Set. 76-inch (193 cm) length, with IVEX-HP Filter.
- List 2425-02: Nonvented Dual-Channel Cassette with Soluset 150 x 60 Microdrip. 124-inch (315 cm) dual-channel, inline cassette with two Y-injection sites, and Secure Lock.
- List 2427-02: Vented Nitroglycerin Dual-Channel Infusion Set. 107-inch (272 cm) dual-channel, inline cassette with Secure Lock.

- List 6440-02: Vented Microdrip[®] Single-Channel Infusion Set. 107-inch (272 cm) precision drop anesthesia set, with inline single-channel cassette and Secure Lock (no Y-injection site).
- List 11003-02: Vented IV Fat Emulsion Dual-Channel Infusion Set. 104-inch (264 cm) IV fat emulsion set with non-phthalate tubing, inline dual-channel cassette, distal Y-injection site, and Secure Lock.

ACCESSORIES

- List 1907-25: LifeCare Flow Detector - for use on primary line of Plum 1.6 Series Infusers.

Note: The Abbott Shaw LifeCare Flow Detector is identical to the LifeCare 5000 Flow Detector.

- List 1969: Vented PlumSet. 18-inch (46 cm) with detached 19-gauge needle and Secure Lock.
- List 3047: Nonvented Dual-Channel Secondary IV Set. 14-inch (36 cm); priming volume 2 mL. With preattached 19-gauge needle and locking device. For use with dual-channel cassettes.
- List 3260: Nonvented PlumSet. 17-inch (44 cm) with detached 19-gauge needle and Secure Lock.
- List 9292: Syringe Adapter. To accommodate syringes into dual-channel cassettes. 19-gauge needle provided.
- List 9293: Vial Adapter. To accommodate vials into dual-channel cassettes. 19-gauge needle provided.
- List 9294: Secondary Container Support. To provide protective support for syringes and vials.
- List 9295: Mini-Pole Replacement. To replace the mini-pole in case of damage.

LifeCare 5000 DataPort Accessories

- List 11429 Junction-Box
- List 11431-01 Plum to PC cable. 8-foot, DB-15 to female DB-9 connector
- List 11431-02 Plum to PC cable. 8-foot, DB-15 to female DB-25 connector
- List 11431-03 Junction-Box to PC cable. 8-foot, 6-wire 6-pin modular jack to female DB-9 connector
- List 11431-04 Junction-Box to PC cable. 8-foot, 6-wire 6-pin modular jack to female DB-25 connector

-
- List 11431-06 Junction-Box to Junction-Box cable. 2-foot, 6-wire 6-pin modular jack to 6-wire 6-pin modular jack
 - List 11431-07 Junction-Box to Junction-Box cable. 4-foot, 6-wire 6-pin modular jack to 6-wire 6-pin modular jack
 - List 11431-08 Junction-Box to Junction-Box cable. 8-foot, 6-wire 6-pin modular jack to 6-wire 6-pin modular jack

This page intentionally left blank.

Section 10

SPECIFICATIONS

PHYSICAL:

- Dimensions:** Approximately 18 x 23 x 23 cm (7 x 9 x 9 in), excluding pole clamp protrusion and power cord storage.
- Weight:** Approximately 6.0 kg (13 lb), with battery.
- Casing:** High-impact plastic.

ELECTRICAL:

- Power Requirements:** 110-120 VAC, 50/60 Hz, 30 W.
- Power Cord:** Hospital-grade AC cord. 8 ft long, with transparent plug and retainer plate.
- Fuses:** 0.5 A, 250 V, Slow Blowing.
- Battery:** One sealed, lead-acid, rechargeable 8 V battery, internal to device. Accessible for ease of field replacement, with color-coded leads and polarized connector.
- Battery life (new batteries, full charge, at 20° C):**
Approximately 500 mL total volume delivered or six hours of operation, whichever occurs first.
- Recharge:** Battery on recharge at any time unit is plugged in.
Recharge rate: to 80% of prior charge in 16 hours while operating at a delivery rate of 125 mL/hr or lower.
- Self-Discharge:** 50% of charge retained for at least one month when unit is neither plugged in nor operating.
- Electrical Leakage:** Risk current limits meet AAMI/ANSI SCL (ungrounded) 12/78 standard.

- ENVIRONMENT:** 10-40° C, 10-90% humidity.

DELIVERY RATE RANGE:

- Micro Mode:** 0.1 to 99.9 mL/hr (in 0.1 mL increments).

The total of the primary rate plus the secondary rate cannot exceed 99.9 mL/hr in Micro Mode.

Note: While using the concurrent delivery feature in the Micro Mode, neither the primary rate nor the secondary rate can be less than 0.5 mL/hr.



Macro Mode: 1 to 999 mL/hr (in 1 mL increments).

The total of the primary rate plus the secondary rate cannot exceed 700 mL/hr in Macro Mode.

DOSE LIMIT RANGE:

Micro Mode: 0.1 to 999 mL (in 0.1 mL increments).

Macro Mode: 1 to 9999 mL (in 1 mL increments).

OPERATING BACKPRESSURE: -2 to 10 psig.

The maximum pressure is user-selectable from 1 to 10 psig, via the front panel touchswitches.

SECONDARY DOSES: For dual-channel delivery, a single dose of a secondary fluid may be administered.

For multidose delivery, 1 to 24 doses of a secondary fluid may be administered at intervals from 15 minutes to 24 hours.

OCCLUSION ALARM:

Distal: The DISTAL OCCLUSION alarm sounds within two pumping cycles after the distal set tubing or set outlet fitting becomes occluded.

Proximal: The PROXIMAL OCCLUSION alarm sounds within five pumping cycles if the tubing proximal to the cassette becomes occluded.

AIR-IN-LINE ALARM:

Distal: The STOPPED AIR IN DISTAL LINE alarm will sound if a bubble 100 μ L or larger passes the distal air-in-line sensors. (The alarm may actually sound at detection of a bubble as small as 50 μ L.)

Proximal: The STOPPED AIR IN PROXIMAL LINE alarm will sound if approximately 1200 μ L or more passes through the proximal air-in-line sensors.

**NURSE-CALL
SYSTEM:**

NURSE-CALL alarm is factory set for Normally Open (NO).

Note: Contact the Technical Services Center to make an internal adjustment to change the Infuser from a Normally-Open (NO) to Normally-Closed (NC) system.

FLOW DETECTOR:

Optional. Detects drops when attached to the primary site chamber. Used to identify empty container conditions.

This page intentionally left blank.

Section 11

WARRANTY

The LifeCare[®] 5000 Plum Infusion System With DataPort[™] has been carefully manufactured using high-quality components. It is warranted to be free from defects in material and workmanship for a period of one year from the date of purchase under normal use and service. On return to Abbott, the Infuser will be repaired or replaced within the terms of this warranty. Material returned to Abbott must be properly packaged and sent freight prepaid.

The warranty on the replaceable battery is limited to 90 days under normal use and service.

This warranty shall not apply if the Infuser has been repaired by anyone other than qualified service personnel, or altered in any way which, in Abbott's judgment, affects its stability or reliability, or if the serial number has been altered, effaced, or removed.

THIS WARRANTY IS IN LIEU OF ALL OTHER WARRANTIES EXPRESS OR IMPLIED.

This page intentionally left blank.

For customer service within the United States, contact:

1-800-ABBOTT3 (1-800-222-6883)

For technical assistance and product return authorization within the United States, contact:

1-800-241-4002

After authorization, ship prepaid product returns to the following address:

Abbott Laboratories
Technical Support Operations
755 Jarvis Drive
Morgan Hill, CA 95037

Note: Outside the U.S., contact your local Abbott Laboratories sales office.

CAUTION: Federal (USA) law restricts this device to sale by or on the order of a physician or other licensed practitioner.

WARNING

A POSSIBLE EXPLOSION HAZARD EXISTS IF THE DEVICE IS USED IN THE PRESENCE OF FLAMMABLE ANESTHETICS.

Covered by the following U.S. Patents: 4,552,336, 4,639,245, and 4,703,775.

Plum, PlumSet, ADD-Vantage, Aqualite, Hema, LifeCare, Soluset, and Microdrip are registered trademarks of Abbott Laboratories. DataPort is a trademark of Abbott Laboratories. IVEX is a registered trademark of Millipore Corporation. Velcro is a registered trademark of Velcro USA, Inc. Cidex is a registered trademark of Arbrook Laboratories. pHisoHex is a registered trademark of Winthrop Laboratories. 7X is a registered trademark of Linbro Scientific, Inc. Super Edisonite is a registered trademark of S. M. Edison Chemical Co.



NRTL/C
CSA 22.2
No. 125
UL 544

CSA is a registered trademark of the Canadian Standards Association. The use of NRTL/C adjacent to the CSA mark indicates that the product has been certified by CSA to U.S. and Canadian standards. CSA has been accredited by the U.S. Occupational Safety and Health Administration (OSHA), as a Nationally Recognized Test Laboratory (NRTL).

Printed in USA

Abbott Laboratories ☐ North Chicago ☐ Illinois 60064 USA



To Purchase, Visit Avobus.com or call [1-800-674-3655](tel:1-800-674-3655)